

VULCRAFT® STEEL DECK - LRFD

NUCOR®
VULCRAFT

VULCRAFT® DECK SOLUTIONS



Catalog Solutions



Web Based Solutions

General

Product Offer Information



Bekaert Steel Fiber Information

Pour Stop Selection Table

Non-Composite Slab Design

Cellular Deck Design Guidance

Acoustical Solutions



Acoustical Roof Deck – NRC Ratings

2.0D FormLok® Deck-Slab - STC & IIC Ratings

3.5D FormLok® Deck-Slab - STC & IIC Ratings

UL Fire Ratings



UL Fire Ratings - Roof Deck

UL Fire Ratings - Floor Deck

Hanging Solutions



Sammy X-Press for Roof Deck

Wedge-Nut for FormLok® Dovetail Deck-Slab



Steel Deck Roving Load - Web Based Design Tool

Approvals - Download PDF

IAPMO UES Report ER-652 for Vulcraft Deck and Deck-Slabs

IAPMO UES Report ER-423 for Dovetail Deck and Deck-Slabs



FM Approval Reports

Vulcraft Deck CSI Guide Spec

Dovetail Deck CSI Guide Spec

Roof Deck



Steel Deck Uniform Loads - Web Based Design Tool

Steel Deck Web-Crippling - Web Based Design Tool

Steel Deck Diaphragm Strength - Web Based Design Tool

LRFD Roof Deck (Properties and Vertical Load Tables)

2.0D Dovetail Roof Deck

3.5D Dovetail Roof Deck



1.5B-36/1.5BI-36/1.5PLB-36 GR50 Roof Deck

1.5B-36/1.5BI-36/1.5PLB-36 GR80 Roof Deck

3NL-32/3NI-32/3PLN-32 GR50 Roof Deck

3NL-32/3NI-32/3PLN-32 GR80 Roof Deck

3N-24/3NI-24 Roof Deck

2.0DA Dovetail Acoustical Roof Deck

3.5DA Dovetail Acoustical Roof Deck



1.5BA-36/1.5BIA-36/1.5PLBA-36 GR50 Acoustical Roof Deck

1.5BA-36/1.5BIA-36/1.5PLBA-36 GR80 Acoustical Roof Deck

3NLA-32/3NIA-32/3PLNA-32 GR50 Acoustical Roof Deck

3NLA-32/3NIA-32/3PLNA-32 GR80 Acoustical Roof Deck

3NA-24/3NIA-24 Acoustical Roof Deck

VULCRAFT® DECK SOLUTIONS



Catalog Solutions



Web Based Solutions

Composite Deck



Unshored Span - Web Based Design Tool

Composite Deck-Slab Strength (Superimposed Load) - Web Based Design Tool

Composite Deck Diaphragm Strength - Web Based Design Tool

LRFD Composite Deck (Properties and Superimposed Load Tables)

2.0D FormLok® Dovetail Deck-Slab

3.5D FormLok® Dovetail Deck-Slab



1.5VL-36/1.5VLI-36/1.5PLVLI-36 Composite Deck-Slab

1.5VLR-36 Composite Deck-Slab

2VLI-36/2VLJ-36/2PLVLI-36 Composite Deck-Slab

3VLI-36/3VLJ-36/3PLVLI-36 Composite Deck-Slab

Non-Composite Deck

LRFD Non-Composite Deck (Properties and Vertical Load Tables)

0.6C-30/0.6C-35 Non-Composite Deck

0.6C-36 Non-Composite Deck



1.0C-32 Non-Composite Deck

1.0C-33 Non-Composite Deck

1.0C-36 Non-Composite Deck

1.3C-32 Non-Composite Deck

1.5C-36 Non-Composite Deck

2C-36 Non-Composite Deck

3C-36 Non-Composite Deck

Cellular Deck

LRFD Cellular Deck (Properties Tables)

1.5BP-36/1.5PLBP-36/1.5VLP-36/1.5PLVLP-36 Cellular Deck

1.5BPA-36/1.5PLBPA-36/1.5VLPA-36/1.5PLVLP-36 Acoustical Cellular Deck

3NP-32/3PLNP-32 Cellular Deck

3NPA-32/3PLNPA-32 Acoustical Cellular Deck



3NP-24 Cellular Deck

3NPA-24 Acoustical Cellular Deck

2VLP-36/2PLVLP-36 Cellular Deck

2VLPA-36/2PLVLP-36 Acoustical Cellular Deck

3VLP-36/3PLVLP-36 Cellular Deck

3VLPA-36/3PLVLP-36 Acoustical Cellular Deck



GENERAL

VULCRAFT® DECK PRODUCT OFFER

ROOF DECKS

1.5B ROOF DECKS

COVER WIDTHS: 30", 36"

GAGES: 24, 22, 20, 19, 18, 16

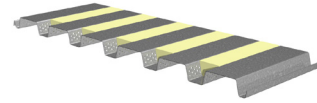
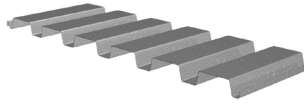

32" WIDE 3N ROOF DECKS

COVER WIDTH: 32"

GAGES: 22, 20, 19, 18, 16

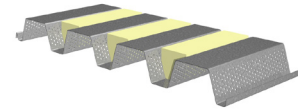

24" WIDE 3N ROOF DECKS

COVER WIDTH: 24"

GAGES: 22, 20, 19, 18, 16

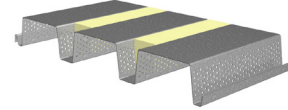
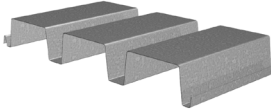

DOVETAIL DECKS

2.0D DOVETAIL DECKS

COVER WIDTH: 24.5"

GAGES: 22, 20, 19, 18, 16

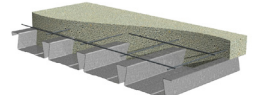
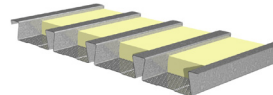
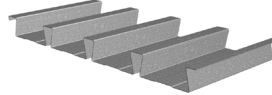

3.5D DOVETAIL DECKS

COVER WIDTH: 24"

GAGES: 20, 19, 18, 16

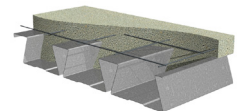
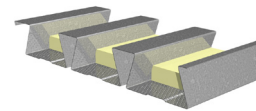
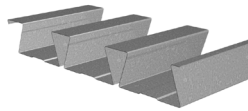

COMPOSITE DECKS

1.5VL COMPOSITE DECKS

COVER WIDTH: 36"

GAGES: 22, 20, 19, 18, 16

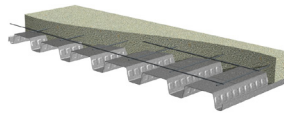

1.5VLR COMPOSITE DECKS

COVER WIDTH: 36"

GAGES: 22, 20, 19, 18, 16

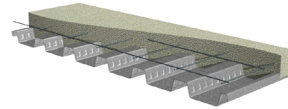

2VLI COMPOSITE DECKS

COVER WIDTH: 36"

GAGES: 22, 20, 19, 18, 16

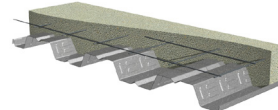

3VLI COMPOSITE DECKS

COVER WIDTH: 36"

GAGES: 22, 20, 19, 18, 16

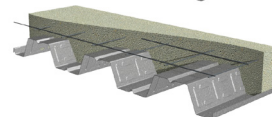

NON-COMPOSITE DECKS

0.6C NON-COMPOSITE DECKS

COVER WIDTHS: 30", 35", 36"

GAGES: 28, 26, 24, 22

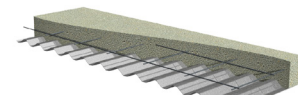
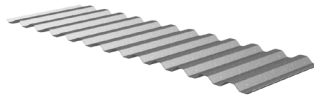

1.0C NON-COMPOSITE DECKS

COVER WIDTHS: 32", 33", 36"

GAGES: 26, 24, 22, 20

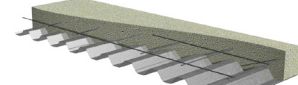

1.3C NON-COMPOSITE DECKS

COVER WIDTH: 32"

GAGES: 26, 24, 22, 20

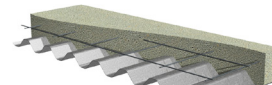

1.5C NON-COMPOSITE DECKS

COVER WIDTHS: 30", 36"

GAGES: 24, 22, 20, 18

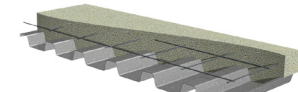

2C NON-COMPOSITE DECKS

COVER WIDTH: 36"

GAGES: 22, 20, 18, 16

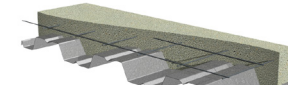
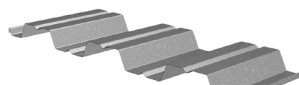

3C NON-COMPOSITE DECKS

COVER WIDTH: 36"

GAGES: 22, 20, 18, 16

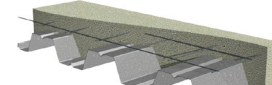
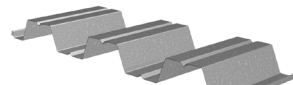

VULCRAFT® DECK PRODUCT OFFER

CELLULAR DECK PRODUCT OFFER

1.5BP CELLULAR DECKS

COVER WIDTH: 24", 36"

GAGES: 20/20, 20/18, 18/20, 18/18,
18/16, 16/18, 16/16

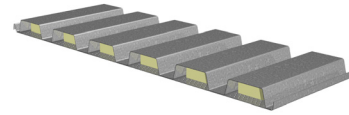
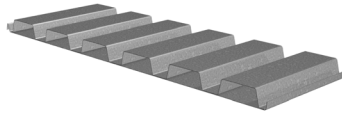

1.5VLP CELLULAR DECKS

COVER WIDTH: 24", 36"

GAGES: 20/20, 20/18, 18/20, 18/18,
18/16, 16/18, 16/16

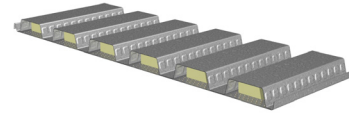
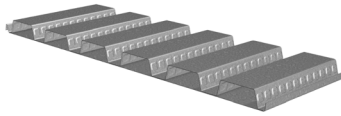

32" WIDE 3NP CELLULAR DECKS

COVER WIDTH: 32"

GAGES: 20/20, 20/18, 18/20, 18/18,
18/16, 16/18, 16/16

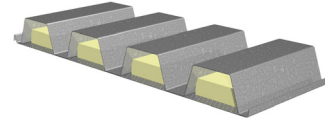
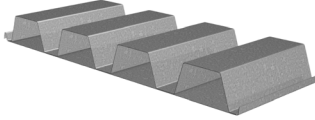

24" WIDE 3NP CELLULAR DECKS

COVER WIDTH: 24"

GAGES: 20/20, 20/18, 18/20, 18/18,
18/16, 16/18, 16/16

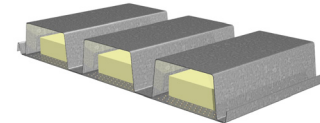
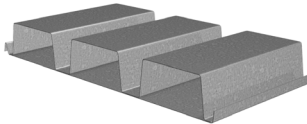

2VLP CELLULAR DECKS

COVER WIDTH: 24", 36"

GAGES: 20/20, 20/18, 18/20, 18/18,
18/16, 16/18, 16/16

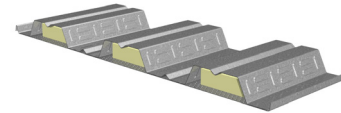
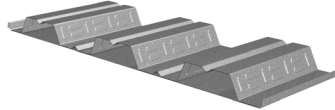

3VLP CELLULAR DECKS

COVER WIDTH: 24", 36"

GAGES: 20/20, 20/18, 18/20, 18/18,
18/16, 16/18, 16/16

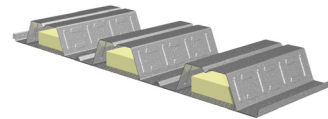
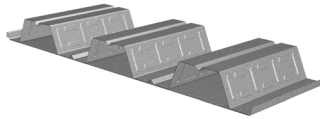

VULCRAFT® COMPOSITE DECKS with BEKAERT DRAMIX® STEEL FIBERS

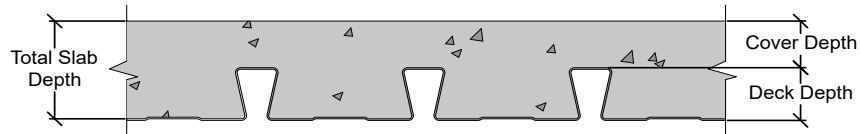

Minimum Reinforcing Options for Temperature and Shrinkage $f'_c = 3000$ psi

Cover Depth (in.)	Min. A_s for T&S (in. ²)	Recommended Reinforcing for Temperature and Shrinkage	
		WWR	(OR) Bekaert Dramix® Steel Fiber Alternate to WWR (lb/yd ³) 4D 65/60BG
Normal Weight Concrete (145 pcf)			
2	0.028	6x6-W1.4xW1.4	23
2¼	0.028	6x6-W1.4xW1.4	20
2½	0.028	6x6-W1.4xW1.4	18
2¾	0.028	6x6-W1.4xW1.4	16
3	0.028	6x6-W1.4xW1.4	15
3¼	0.029	6x6-W2.1xW2.1	15
3½	0.032	6x6-W2.1xW2.1	15
3¾	0.034	6x6-W2.1xW2.1	15
4	0.036	6x6-W2.1xW2.1	15
4¼	0.038	6x6-W2.1xW2.1	15
4½	0.041	6x6-W2.1xW2.1	15
4¾	0.043	6x6-W2.9xW2.9	15
5	0.045	6x6-W2.9xW2.9	15
6	0.054	6x6-W2.9xW2.9	15
Light Weight Concrete (110 pcf)			
2	0.028	6x6-W1.4xW1.4	33
2¼	0.028	6x6-W1.4xW1.4	28
2½	0.028	6x6-W1.4xW1.4	25
2¾	0.028	6x6-W1.4xW1.4	22
3	0.028	6x6-W1.4xW1.4	20
3¼	0.029	6x6-W2.1xW2.1	20
3½	0.032	6x6-W2.1xW2.1	20
3¾	0.034	6x6-W2.1xW2.1	20
4	0.036	6x6-W2.1xW2.1	20
4¼	0.038	6x6-W2.1xW2.1	20
4½	0.041	6x6-W2.1xW2.1	20
4¾	0.043	6x6-W2.9xW2.9	20
5	0.045	6x6-W2.9xW2.9	20
6	0.054	6x6-W2.9xW2.9	20

Notes:

1. FRC reinforcement is based on IAPMO UES ER-465.
2. Dramix® fibers may be used in UL or ULC fire rated assemblies in lieu of WWR. See UL file R19307 for additional information.

For information on Bekaert Dramix® fibers contact 770-514-2295 or infobuilding@bekaert.com.

VULCRAFT® COMPOSITE DECKS with BEKAERT DRAMIX® STEEL FIBERS

3½" Deep Decks

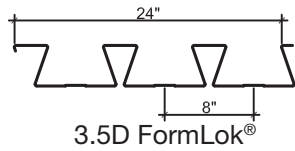

3" Deep Decks

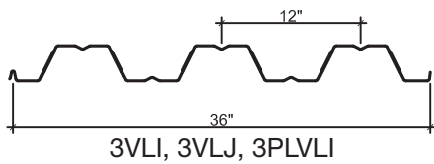

2" Deep Decks

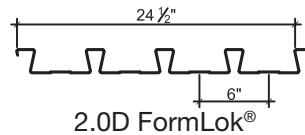
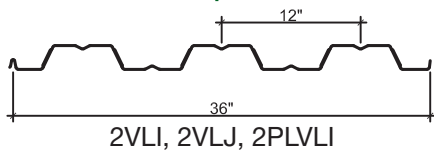

1½" Deep Decks

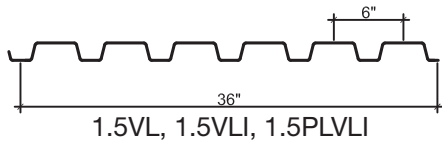

Composite Deck Slab

Total Slab Depth (in.)	Cover Depth (in.)			
	3½" Deep Decks	3" Deep Decks	2" Deep Decks	1½" Deep Decks
	Vulcraft Composite Decks			
	3.5D	3VLI, 3VLJ, 3PLVLI	2VLI, 2VLJ, 2PLVLI, 2.0D	1.5VL, 1.5VLI, 1.5PLVLI, 1.5VLR
3 1/2	-	-	-	2
3 3/4	-	-	-	2 1/4
4	-	-	2	2 1/2
4 1/4	-	-	2 1/4	2 3/4
4 1/2	-	-	2 1/2	3
4 3/4	-	-	2 3/4	3 1/4
5	-	2	3	3 1/2
5 1/4	-	2 1/4	3 1/4	3 3/4
5 1/2	2	2 1/2	3 1/2	4
5 3/4	2 1/4	2 3/4	3 3/4	4 1/4
6	2 1/2	3	4	4 1/2
6 1/4	2 3/4	3 1/4	4 1/4	4 3/4
6 1/2	3	3 1/2	4 1/2	5
6 3/4	3 1/4	3 3/4	4 3/4	5 1/4
7	3 1/2	4	5	5 1/2
7 1/4	3 3/4	4 1/4	5 1/4	5 3/4
7 1/2	4	4 1/2	5 1/2	6
7 3/4	4 1/4	4 3/4	5 3/4	-
8	4 1/2	5	6	-

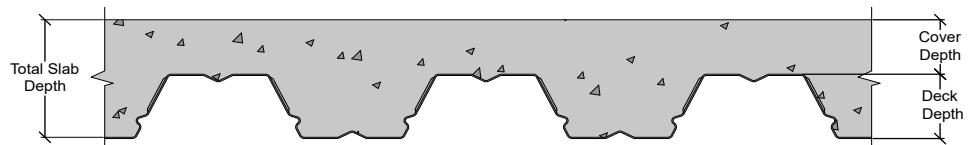

NOTICE: Design defects that could cause injury or death may result from relying on the information in this document without independent verification by a qualified professional. The information in this document is provided "AS IS". Nucor Corporation and its affiliates expressly disclaim: (i) any and all representations, warranties and conditions and (ii) all liability arising out of or related to this document and the information in it.

NUCOR, VULCRAFT, VERCO, and FORMLOK are registered trademarks of Nucor. DRAMIX is a registered trademark of Bekaert.

VULCRAFT® COMPOSITE DECKS with BEKAERT DRAMIX® STEEL FIBERS

3½" Deep Decks

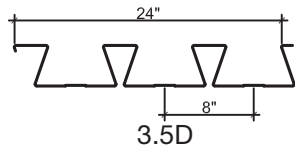

3" Deep Decks

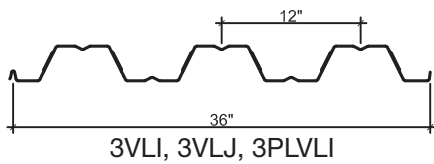

2" Deep Decks

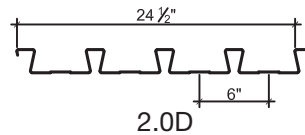
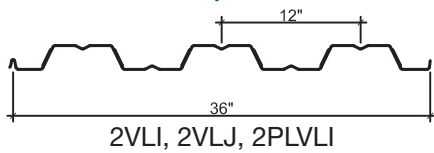

1½" Deep Decks

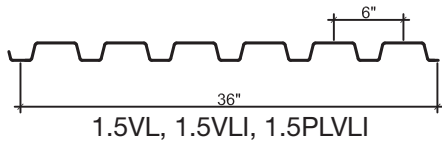

Composite Deck Slab

Total Slab Depth (in.)	Cover Depth (in.)			
	3½" Deep Decks	3" Deep Decks	2" Deep Decks	1½" Deep Decks
	Vulcraft Composite Decks			
	3.5D	3VLI, 3VLJ, 3PLVLI	2VLI, 2VLJ, 2PLVLI, 2.0D	1.5VL, 1.5VLI, 1.5PLVLI, 1.5VLR
3 1/2	-	-	-	2
3 3/4	-	-	-	2 1/4
4	-	-	2	2 1/2
4 1/4	-	-	2 1/4	2 3/4
4 1/2	-	-	2 1/2	3
4 3/4	-	-	2 3/4	3 1/4
5	-	2	3	3 1/2
5 1/4	-	2 1/4	3 1/4	3 3/4
5 1/2	2	2 1/2	3 1/2	4
5 3/4	2 1/4	2 3/4	3 3/4	4 1/4
6	2 1/2	3	4	4 1/2
6 1/4	2 3/4	3 1/4	4 1/4	4 3/4
6 1/2	3	3 1/2	4 1/2	5
6 3/4	3 1/4	3 3/4	4 3/4	5 1/4
7	3 1/2	4	5	5 1/2
7 1/4	3 3/4	4 1/4	5 1/4	5 3/4
7 1/2	4	4 1/2	5 1/2	6
7 3/4	4 1/4	4 3/4	5 3/4	6 1/4
8	4 1/2	5	6	6 1/2

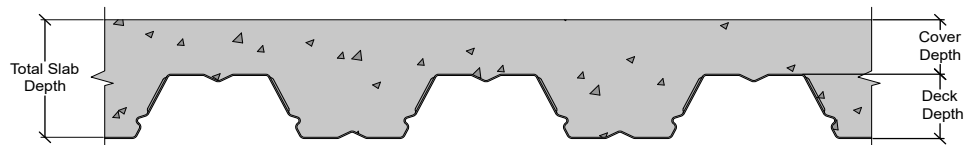

NOTICE: Design defects that could cause injury or death may result from relying on the information in this document without independent verification by a qualified professional. The information in this document is provided "AS IS". Nucor Corporation and its affiliates expressly disclaim: (i) any and all representations, warranties and conditions and (ii) all liability arising out of or related to this document and the information in it.

NUCOR, VULCRAFT, VERCO, and FORMLOK are registered trademarks of Nucor. DRAMIX is a registered trademark of Bekaert.

NON-COMPOSITE SLAB DESIGN

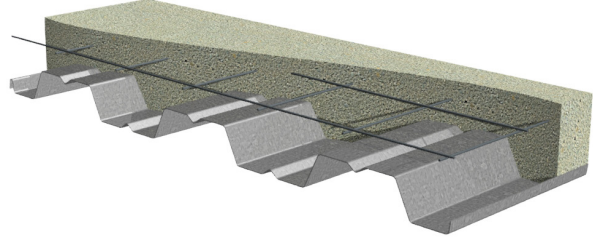
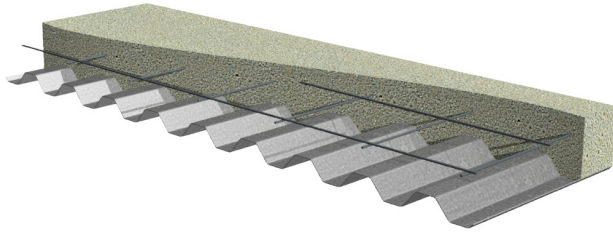

Design Notes for Reinforced Concrete Slabs

Concrete Design - Design of concrete slabs in accordance with ACI is the responsibility of the structural engineer of record. Values listed in these tables are provided as an aid in selecting the appropriate deck and Vulcraft does not assume responsibility for the design of the slab.

Temperature and Shrinkage Reinforcing - Temperature and shrinkage effects in the concrete shall be controlled by methods permitted by ACI 318. The designer shall be permitted to consider only the area of concrete above the deck.

Shoring - Slabs temporarily shored during construction must deduct the weight of the slab from the calculated capacity of the reinforced concrete slab.

Deck Finish - Galvanized form deck can be considered a permanent support in most applications. When uncoated or painted deck is used, the weight of the concrete slab shall be deducted from the calculated capacity of the reinforced concrete slab.

Allowable Slab Loads - These tables are based on an interior three span condition using moment coefficients from ACI 318- 14 Section 6.5.2. Moment coefficients must be adjusted for end spans, single spans, or double spans.

$f'_c = 3,000 \text{ psi}$	$\phi = 0.90$	$b = 12 \text{ in}$	$+ M = (W L^2)/16$	$+ M_c = T (d-a/2)/12$
$f_y = 60,000 \text{ psi}$	$T = A_s f_y$	$a = T/0.85 f'_c b$	$- M = (W L^2 (L \leq 10 \text{ ft.}))/12$	$- M_c = T (d-na)/12$
			$- M = (W L^2 (L > 10 \text{ ft.}))/10$	$M_L = \phi M_c/1.6$

Serviceability - Tabulated values are not evaluated for deflection.

Span Ratio - The tabulated concrete cover thicknesses (t) for the table values shown meet the ratio of span/28 per ACI 318-14 Section 7.3.1.5.

Reinforcing Placement - Reinforcing shall be located at center of topping.

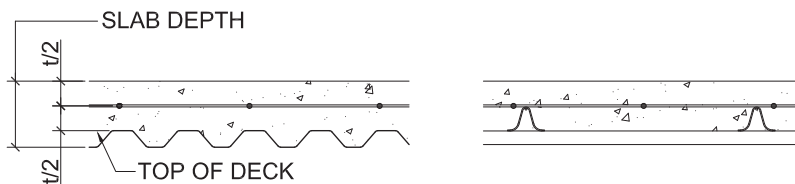

Venting Non-Composite Deck - Check with Vulcraft representative for availability.

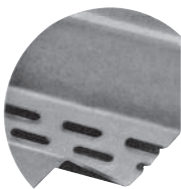

SLOT VENTS

- 0.6C, 1.0C and 1.3C – Do not include slot vents in bottom flange. Sidelap vents optional.
- 0.6CSV, 1.0CSV and 1.3CSV – Specify if bottom flange slot vents are required.

NOTICE: Design defects that could cause injury or death may result from relying on the information in this document without independent verification by a qualified professional. The information in this document is provided "AS IS". Nucor Corporation and its affiliates expressly disclaim: (i) any and all representations, warranties and conditions and (ii) all liability arising out of or related to this document and the information in it.

REINFORCED CONCRETE SLABS ON NC DECK

ALLOWABLE SUPERIMPOSED UNIFORM LOADS (psf) FOR 0.6C DECK

3 Span Condition

Slab Depth		Reinforcement		Clear Span (ft-in.)											
Total	Topping	WWR	A _s	2'-0"	2'-3"	2'-6"	2'-9"	3'-0"	3'-3"	3'-6"	3'-9"	4'-0"	4'-6"	5'-0"	
2"	1½"	6x6-W2.1xW2.1	0.042	251	198	161	133	112	95	82					
		6x6-W2.9xW2.9	0.058	339	268	217	179	151	128	111					
		6x6-W4.0xW4.0	0.080	400	358	290	240	201	172	148					
2½"	2"	6x6-W2.9xW2.9	0.058	400	365	295	244	205	175	151	131	115	91		
		6x6-W4.0xW4.0	0.080	400	400	398	329	276	236	203	177	156	123		
		4x4-W2.9xW2.9	0.087	400	400	400	355	298	254	219	191	168	133		
3"	2½"	6x6-W2.9xW2.9	0.058	400	400	374	309	260	221	191	166	146	115	93	
		6x6-W4.0xW4.0	0.080	400	400	400	400	351	299	258	225	198	156	127	
		4x4-W2.9xW2.9	0.087	400	400	400	400	380	324	279	243	214	169	137	
3½"	3"	6x6-W4.0xW4.0	0.080	400	400	400	400	400	363	313	273	240	190	154	
		4x4-W2.9xW2.9	0.087	400	400	400	400	400	393	339	295	260	205	166	
		4x4-W4.0xW4.0	0.120	400	400	400	400	400	400	400	398	350	276	224	
4"	3½"	6x6-W4.0xW4.0	0.080	400	400	400	400	400	400	368	321	282	223	181	
		4x4-W2.9xW2.9	0.087	400	400	400	400	400	400	399	348	305	241	196	
		4x4-W4.0xW4.0	0.120	400	400	400	400	400	400	400	400	400	326	264	
4½"	4"	4x4-W2.9xW2.9	0.087	400	400	400	400	400	400	400	400	351	278	225	
		4x4-W4.0xW4.0	0.120	400	400	400	400	400	400	400	400	400	376	305	
		#3 @ 9" o.c.	0.147	400	400	400	400	400	400	400	400	400	400	400	368

ALLOWABLE SUPERIMPOSED UNIFORM LOADS (psf) FOR 1.0C DECK

3 Span Condition

Slab Depth		Reinforcement		Clear Span (ft-in.)											
Total	Topping	WWR	A _s	3'-0"	3'-3"	3'-6"	3'-9"	4'-0"	4'-6"	5'-0"	5'-6"	6'-0"	6'-6"	7'-0"	
2½"	1½"	6x6-W2.1xW2.1	0.042	112	95	82	71								
		6x6-W2.9xW2.9	0.058	151	128	111	96								
		6x6-W4.0xW4.0	0.080	201	172	148	129								
3"	2"	6x6-W2.9xW2.9	0.058	205	175	151	131	115	91						
		6x6-W4.0xW4.0	0.080	276	236	203	177	156	123						
		4x4-W4.0xW4.0	0.120	397	338	292	254	223	176						
3½"	2½"	6x6-W2.9xW2.9	0.058	260	221	191	166	146	115	93	77				
		6x6-W4.0xW4.0	0.080	351	299	258	225	198	156	127	105				
		4x4-W4.0xW4.0	0.120	400	400	374	326	287	226	183	152				
4"	3"	6x6-W4.0xW4.0	0.080	400	363	313	273	240	190	154	127	107	91	78	
		4x4-W2.9xW2.9	0.087	400	393	339	295	260	205	166	137	115	98	85	
		4x4-W4.0xW4.0	0.120	400	400	400	398	350	276	224	185	156	133	114	
4½"	3½"	6x6-W4.0xW4.0	0.080	400	400	368	321	282	223	181	149	125	107	92	
		4x4-W2.9xW2.9	0.087	400	400	399	348	305	241	196	162	136	116	100	
		4x4-W4.0xW4.0	0.120	400	400	400	400	400	326	264	219	184	156	135	
5"	4"	4x4-W2.9xW2.9	0.087	400	400	400	400	351	278	225	186	156	133	115	
		4x4-W4.0xW4.0	0.120	400	400	400	400	400	376	305	252	212	180	156	
		#3 @ 9" o.c.	0.147	400	400	400	400	400	400	368	304	256	218	188	

REINFORCED CONCRETE SLABS ON NC DECK

ALLOWABLE SUPERIMPOSED UNIFORM LOADS (psf) FOR 1.3C DECK

3 Span Condition

Slab Depth		Reinforcement		Clear Span (ft-in.)										
Total	Topping	WWR	A _s	4'-0"	4'-6"	5'-0"	5'-6"	6'-0"	6'-6"	7'-0"	7'-6"	8'-0"	8'-6"	9'-0"
3 ⁵ / ₁₆ "	2"	6x6-W2.9xW2.9	0.058	115	91									
		6x6-W4.0xW4.0	0.080	156	123									
		4x4-W2.9xW2.9	0.087	168	133									
3 ¹³ / ₁₆ "	2½"	6x6-W2.9xW2.9	0.058	146	115	93	77							
		6x6-W4.0xW4.0	0.080	198	156	127	105							
		4x4-W2.9xW2.9	0.087	214	169	137	113							
4 ⁵ / ₁₆ "	3"	6x6-W4.0xW4.0	0.080	240	190	154	127	107	91	78				
		4x4-W2.9xW2.9	0.087	260	205	166	137	115	98	85				
		4x4-W4.0xW4.0	0.120	350	276	224	185	156	133	114				
4 ¹³ / ₁₆ "	3½"	6x6-W4.0xW4.0	0.080	282	223	181	149	125	107	92	80	71		
		4x4-W2.9xW2.9	0.087	305	241	196	162	136	116	100	87	76		
		4x4-W4.0xW4.0	0.120	400	326	264	219	184	156	135	118	103		
5 ⁵ / ₁₆ "	4"	4x4-W2.9xW2.9	0.087	351	278	225	186	156	133	115	100	88	78	69
		4x4-W4.0xW4.0	0.120	400	376	305	252	212	180	156	136	119	106	94
		#3 @ 9" o.c.	0.147	400	400	368	304	256	218	188	164	144	127	114
5 ¹³ / ₁₆ "	4½"	4x4-W4.0xW4.0	0.120	400	400	345	285	240	204	176	154	135	120	107
		#3 @ 9" o.c.	0.147	400	400	400	345	290	247	213	186	163	145	129
		#4 @ 12" o.c.	0.196	400	400	400	400	378	322	278	242	213	188	168

ALLOWABLE SUPERIMPOSED UNIFORM LOADS (psf) FOR 1.5C DECK

3 Span Condition

Slab Depth		Reinforcement		Clear Span (ft-in.)										
Total	Topping	WWR	A _s	4'-0"	4'-6"	5'-0"	5'-6"	6'-0"	6'-6"	7'-0"	7'-6"	8'-0"	8'-6"	9'-0"
3½"	2"	6x6-W2.9xW2.9	0.058	115	91									
		6x6-W4.0xW4.0	0.080	156	123									
		4x4-W2.9xW2.9	0.087	168	133									
4"	2½"	6x6-W2.9xW2.9	0.058	146	115	93	77							
		6x6-W4.0xW4.0	0.080	198	156	127	105							
		4x4-W2.9xW2.9	0.087	214	169	137	113							
4½"	3"	6x6-W4.0xW4.0	0.080	240	190	154	127	107	91	78				
		4x4-W2.9xW2.9	0.087	260	205	166	137	115	98	85				
		4x4-W4.0xW4.0	0.120	350	276	224	185	156	133	114				
5"	3½"	6x6-W4.0xW4.0	0.080	282	223	181	149	125	107	92	80	71		
		4x4-W2.9xW2.9	0.087	305	241	196	162	136	116	100	87	76		
		4x4-W4.0xW4.0	0.120	400	326	264	219	184	156	135	118	103		
5½"	4"	4x4-W2.9xW2.9	0.087	351	278	225	186	156	133	115	100	88	78	69
		4x4-W4.0xW4.0	0.120	400	376	305	252	212	180	156	136	119	106	94
		#3 @ 9" o.c.	0.147	400	400	368	304	256	218	188	164	144	127	114
6"	4½"	4x4-W4.0xW4.0	0.120	400	400	345	285	240	204	176	154	135	120	107
		#3 @ 9" o.c.	0.147	400	400	400	345	290	247	213	186	163	145	129
		#4 @ 12" o.c.	0.196	400	400	400	400	378	322	278	242	213	188	168

REINFORCED CONCRETE SLABS ON NC DECK

ALLOWABLE SUPERIMPOSED UNIFORM LOADS (psf) FOR 2C DECK

3 Span Condition

Slab Depth		Reinforcement		Clear Span (ft-in.)										
Total	Topping	WWR	A _s	5'-0"	5'-6"	6'-0"	6'-6"	7'-0"	7'-6"	8'-0"	8'-6"	9'-0"	9'-6"	10'-0"
4½"	2½"	6x6-W2.9xW2.9	0.058	93	77									
		6x6-W4.0xW4.0	0.080	127	105									
		4x4-W2.9xW2.9	0.087	137	113									
5"	3"	6x6-W2.9xW2.9	0.058	113	93	78	67	58						
		6x6-W4.0xW4.0	0.080	154	127	107	91	78						
		4x4-W2.9xW2.9	0.087	166	137	115	98	85						
5½"	3½"	6x6-W4.0xW4.0	0.080	181	149	125	107	92	80	71				
		4x4-W2.9xW2.9	0.087	196	162	136	116	100	87	76				
		4x4-W4.0xW4.0	0.120	264	219	184	156	135	118	103				
6"	4"	4x4-W2.9xW2.9	0.087	225	186	156	133	115	100	88	78	69		
		4x4-W4.0xW4.0	0.120	305	252	212	180	156	136	119	106	94		
		#3 @ 9" o.c.	0.147	368	304	256	218	188	164	144	127	114		
6½"	4½"	4x4-W4.0xW4.0	0.120	345	285	240	204	176	154	135	120	107	96	86
		#3 @ 9" o.c.	0.147	400	345	290	247	213	186	163	145	129	116	104
		#4 @ 12" o.c.	0.196	400	400	378	322	278	242	213	188	168	151	136
7"	5"	4x4-W4.0xW4.0	0.120	386	319	268	228	197	172	151	134	119	107	96
		#3 @ 9" o.c.	0.147	400	386	325	277	239	208	183	162	144	130	117
		#4 @ 12" o.c.	0.196	400	400	400	361	312	271	239	211	188	169	153

ALLOWABLE SUPERIMPOSED UNIFORM LOADS (psf) FOR 3C DECK

3 Span Condition

Slab Depth		Reinforcement		Clear Span (ft-in.)										
Total	Topping	WWR	A _s	6'-6"	7'-0"	7'-6"	8'-0"	8'-6"	9'-0"	9'-6"	10'-0"	10'-6"	11'-0"	11'-6"
5"	2"	6x6-W2.9xW2.9	0.058	44	38	33	29	26	23					
		6x6-W4.0xW4.0	0.080	59	51	44	39	34	31					
		4x4-W2.9xW2.9	0.087	64	55	48	42	37	33					
5½"	2½"	6x6-W2.9xW2.9	0.058	55	48	42	36	32	29	26	23			
		6x6-W4.0xW4.0	0.080	75	65	56	49	44	39	35	32			
		4x4-W4.0xW4.0	0.120	109	94	82	72	63	57	51	46			
6"	3"	6x6-W4.0xW4.0	0.080	91	78	68	60	53	47	43	38	29	26	24
		4x4-W2.9xW2.9	0.087	98	85	74	65	57	51	46	42	31	29	26
		4x4-W4.0xW4.0	0.120	133	114	100	87	77	69	62	56	42	39	35
6½"	3½"	6x6-W4.0xW4.0	0.080	107	92	80	71	62	56	50	45	34	31	28
		4x4-W2.9xW2.9	0.087	116	100	87	76	68	60	54	49	37	34	31
		4x4-W4.0xW4.0	0.120	156	135	118	103	92	82	73	66	50	46	42
7"	4"	4x4-W2.9xW2.9	0.087	133	115	100	88	78	69	62	56	42	39	35
		4x4-W4.0xW4.0	0.120	180	156	136	119	106	94	84	76	58	53	48
		#3 @ 9" o.c.	0.147	218	188	164	144	127	114	102	92	70	63	58
7½"	4½"	4x4-W4.0xW4.0	0.120	204	176	154	135	120	107	96	86	65	59	54
		#3 @ 9" o.c.	0.147	247	213	186	163	145	129	116	104	79	72	66
		#4 @ 12" o.c.	0.196	322	278	242	213	188	168	151	136	103	94	86

CELLULAR DECK DESIGN GUIDANCE

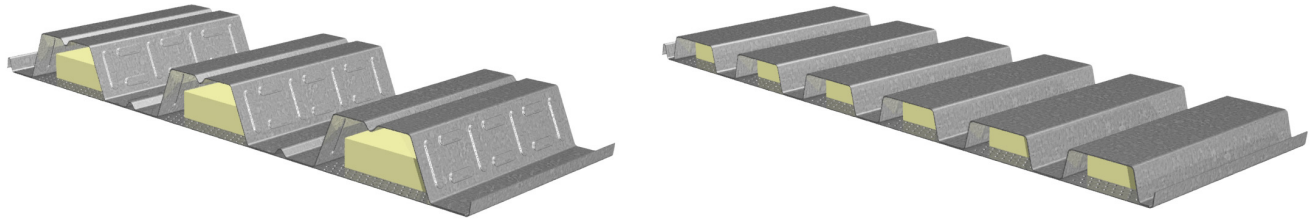

CELLULAR DECK DESIGN

Cellular and cellular acoustical decks may be designed for out-of-plane loads, shoring and diaphragm loads based on the published properties. Superimposed loads are based on the profile and gage of the fluted top section.

Cellular and cellular acoustical decks may be designed based on their fluted top sections ignoring the contribution of the bottom pan, in accordance with the guidelines below. Please contact your Vulcraft representative if more detailed information is required.

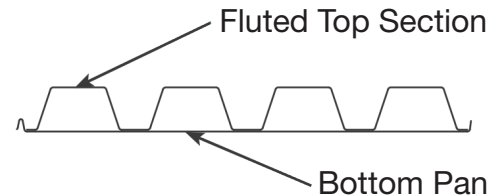

Cellular Roof Decks

- **Out-of-Plane Loads:** Cellular and cellular acoustical decks may be designed for out-of-plane loads based on fluted deck of the same gage and profile as the fluted top section of the cellular deck.
- **Diaphragm Design:** Diaphragm shear strength and stiffness for cellular and cellular acoustical decks may be based on fluted deck of the same profile as the fluted top section but with the gage of the bottom pan.

Cellular Composite Decks

- **Unshored Clear Spans:** Determination of maximum unshored clear spans of cellular and cellular acoustical decks may be based on fluted deck of the same gage and profile as the fluted top section of the cellular deck.

Cellular Composite Deck-Slabs

- **Superimposed Loads:** Superimposed loads for cellular composite and cellular acoustical composite decks with a given concrete type and thickness are based on composite deck of the same profile, gage and concrete as the fluted top section of the cellular deck.
- **Diaphragm Design:** Diaphragm shear strength and stiffness for cellular composite and cellular acoustical composite decks with a given concrete type and thickness may be based on fluted composite deck of the same profile as the fluted top section but with the gage of the bottom pan.

NOTICE: Design defects that could cause injury or death may result from relying on the information in this document without independent verification by a qualified professional. The information in this document is provided "AS IS". Nucor Corporation and its affiliates expressly disclaim: (i) any and all representations, warranties and conditions and (ii) all liability arising out of or related to this document and the information in it.

VULCRAFT NRC ACOUSTICAL SOLUTIONS

DOVETAIL ACOUSTICAL DECKS

REDUCE INTERIOR NOISE WITH THE SOUND ABSORPTION CAPABILITIES OF VULCRAFT ACOUSTICAL ROOF DECK

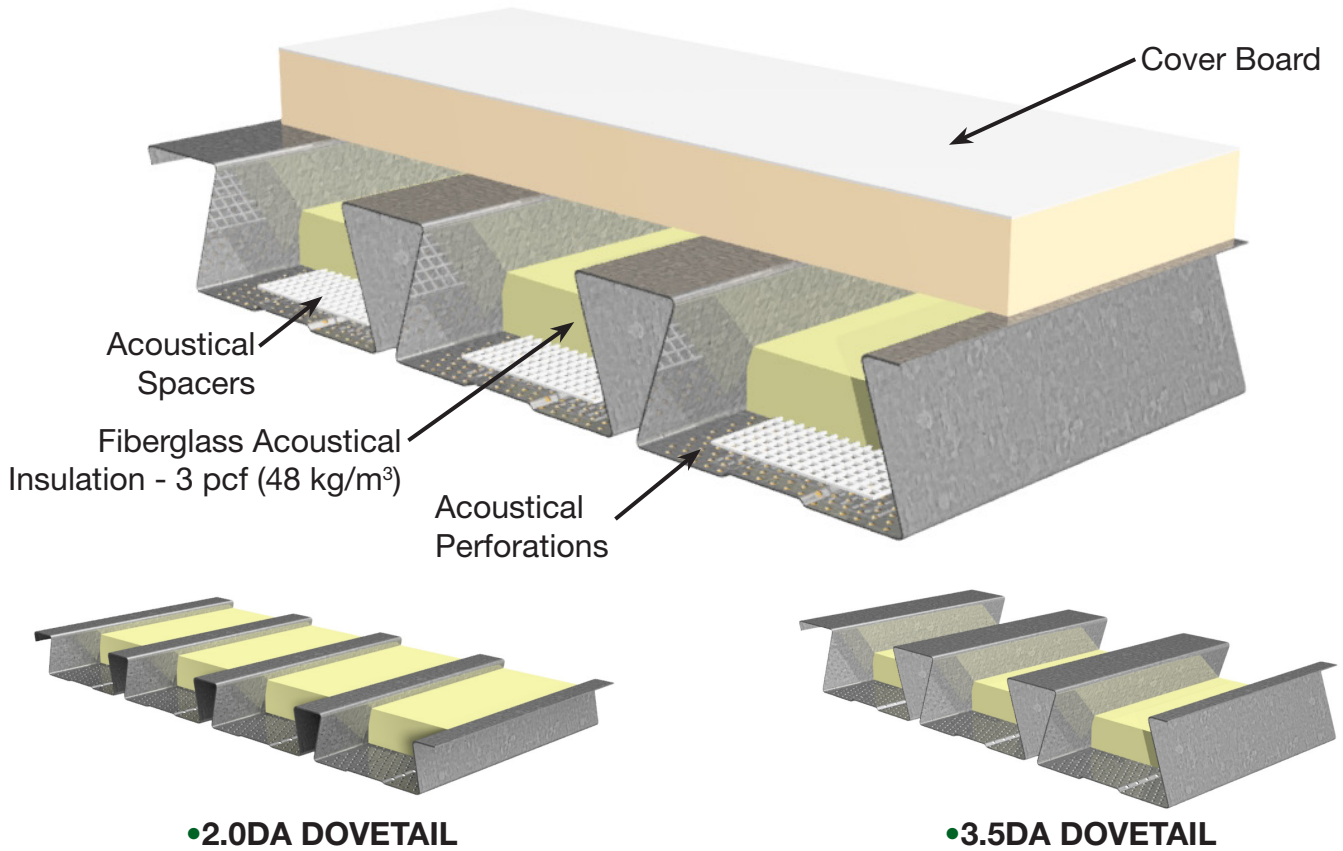

Roof Insulation	AC Insulation	Absorption Coefficients						SSA	NRC	Test. No.
		125 Hz	250 Hz	500 Hz	1000 Hz	2000 Hz	4000 Hz			
2.0DA DOVETAIL										
Poly-Iso	Plain	0.19	0.54	1.15	1.07	1.01	0.79	0.95	0.95	A14-170
	Encapsulated	0.35	0.82	1.15	0.99	0.97	0.72	0.96	1.00	A14-167
Fiberglass	Plain	0.74	1.40	1.25	1.03	0.98	0.80	1.14	1.15	A14-169
	Encapsulated	0.62	1.18	1.08	0.93	0.97	0.77	1.02	1.05	A14-168
½" Roof Board	Plain	0.17	0.51	1.05	1.05	0.85	0.77	0.85	0.85	A19-101
	Encapsulated	0.30	0.56	1.02	0.99	0.92	0.78	0.86	0.85	A19-102
3.5DA DOVETAIL										
Poly-Iso	Plain	0.25	0.74	1.13	1.06	0.97	0.75	0.96	1.00	A14-186
	Encapsulated	0.38	0.86	1.18	1.03	0.93	0.65	0.98	1.00	A14-189
Fiberglass	Plain	0.92	1.51	1.13	1.06	0.98	0.78	1.14	1.15	A14-187
	Encapsulated	0.97	1.50	1.09	1.00	0.91	0.67	1.10	1.15	A14-188
½" Roof Board	Plain	0.21	0.71	1.06	0.91	0.88	0.68	0.88	0.90	AB21-132
	Encapsulated	0.15	0.82	1.07	0.98	0.89	0.68	0.93	0.95	AB21-130

Note:

1. Plain 3.0 pcf (48 kg/m³) fiberglass acoustical insulation standard. Inquire regarding lead time for encapsulated insulation.

VULCRAFT NRC ACOUSTICAL SOLUTIONS

FLUTED ACOUSTICAL DECKS

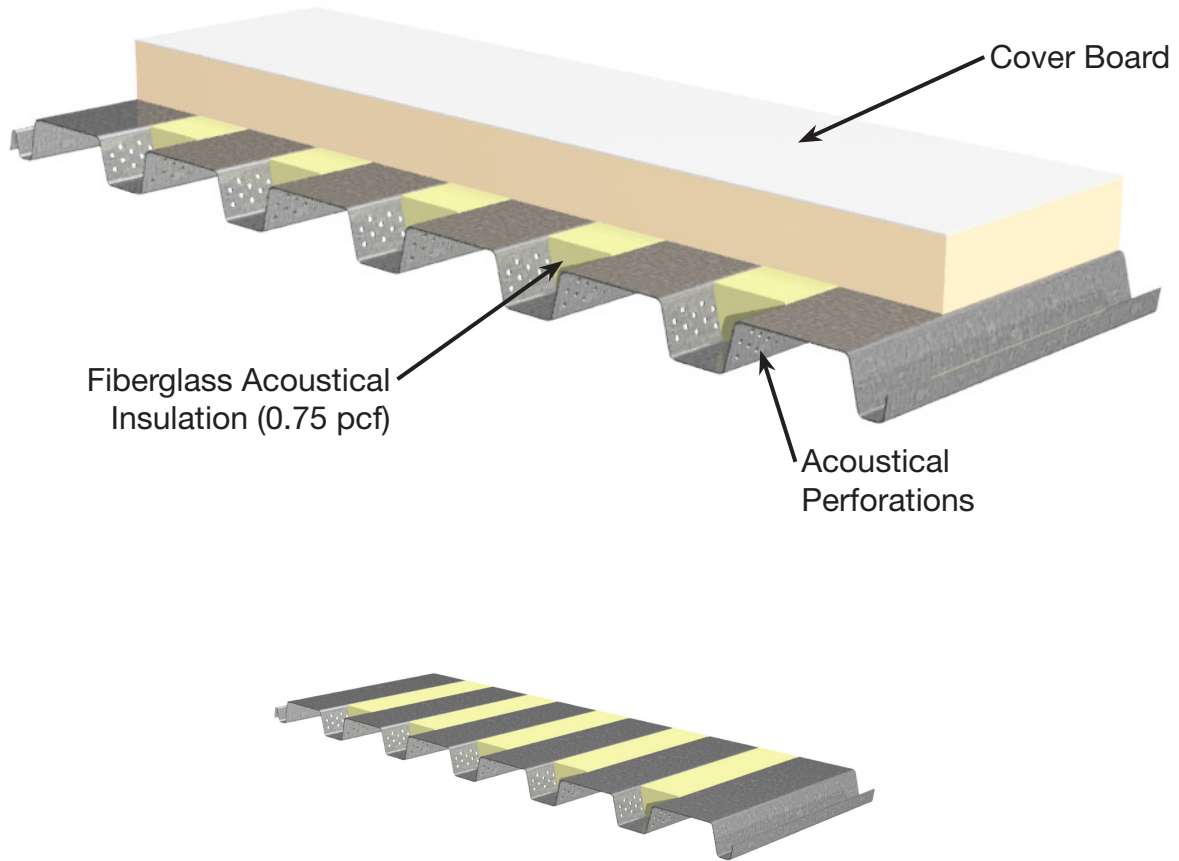

• **1.5BA-36 / 1.5BIA-36 / 1.5PLBA-36**

Roof Insulation	AC Insulation	Absorption Coefficients						SSA	NRC	Test. No.
		125 Hz	250 Hz	500 Hz	1000 Hz	2000 Hz	4000 Hz			
1.5BA-36 / 1.5BIA-36 / 1.5PLBA-36										
Poly-Iso	Plain	0.09	0.20	0.47	0.86	0.55	0.32	0.55	0.55	A15-125
	Encapsulated	0.14	0.35	0.74	0.76	0.44	0.27	0.57	0.55	A15-124
Fiberglass	Plain	0.68	1.16	1.17	0.96	0.52	0.31	0.95	0.95	A15-126
	Encapsulated	0.75	0.83	0.78	0.68	0.42	0.28	0.67	0.70	A15-123

Note:

1. Plain 0.75 pcf (12 kg/m³) fiberglass acoustical insulation standard for all BA decks. Inquire regarding lead time for encapsulated insulation.

VULCRAFT NRC ACOUSTICAL SOLUTIONS

FLUTED ACOUSTICAL DECKS

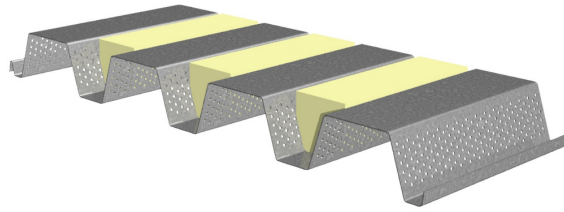

•3NLA-32 / 3NIA-32 / 3PLNA-32

Roof Insulation	AC Insulation	Absorption Coefficients						SSA	NRC	Test. No.
		125 Hz	250 Hz	500 Hz	1000 Hz	2000 Hz	4000 Hz			
3NLA-32 / 3NIA-32 / 3PLNA-32										
2" Poly-Iso	Plain	0.23	0.42	0.85	0.95	0.50	0.41	0.68	0.70	A19-032
	Encapsulated	0.30	0.62	1.09	0.79	0.52	0.31	0.74	0.75	A19-111
2" Fiberglass	Plain	0.78	1.17	1.20	0.98	0.50	0.41	0.96	0.95	A19-031
	Encapsulated	0.89	1.08	1.09	0.74	0.46	0.30	0.83	0.85	A19-110
½" Roof Board	Plain	0.21	0.41	0.81	0.89	0.49	0.41	0.64	0.65	A19-033

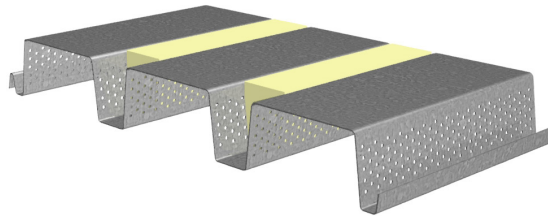

•3NA-24 / 3NIA-24

Roof Insulation	AC Insulation	Absorption Coefficients						SSA	NRC	Test. No.
		125 Hz	250 Hz	500 Hz	1000 Hz	2000 Hz	4000 Hz			
3NA-24 / 3NIA-24										
Poly-Iso	Plain	0.19	0.33	0.73	0.83	0.48	0.33	0.59	0.60	A15-130
	Encapsulated	0.17	0.39	0.94	0.86	0.48	0.27	0.67	0.65	A15-138
Fiberglass	Plain	0.81	1.16	1.15	0.91	0.47	0.27	0.92	0.90	A15-128
	Encapsulated	1.07	1.13	1.04	0.81	0.43	0.26	0.85	0.85	A15-137

Note:

1. Plain 0.75 pcf (12 kg/m³) fiberglass acoustical insulation standard for all NA decks. Inquire regarding lead time for encapsulated insulation.

VULCRAFT NRC ACOUSTICAL SOLUTIONS

CELLULAR ACOUSTICAL DECKS

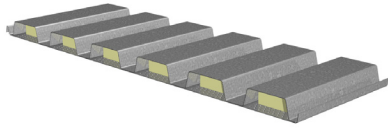

- 1.5BPA-36 / 1.5PLBPA-36 ROOF DECK
- 1.5VLPA-36 / 1.5PLVLPA-36 COMPOSITE DECK

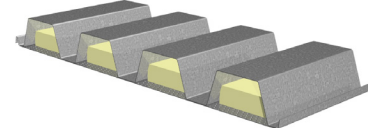

- 3NPA-32 / 3PLNPA-32 ROOF DECK

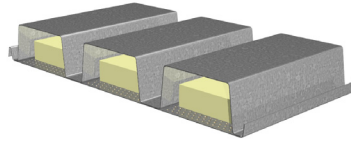

- 3NPA-24 / 3PLNPA-24 ROOF DECK

Roof Insulation	AC Insulation	Absorption Coefficients							SSA	NRC	Test. No.
		125 Hz	250 Hz	500 Hz	1000 Hz	2000 Hz	4000 Hz				
1.5BPA-36 / 1.5PLBPA-36 ROOF DECK OR 1.5VLPA-36 / 1.5PLVLPA-36 COMPOSITE DECK											
Poly-Iso	Plain	0.27	0.32	0.70	1.02	0.80	0.52	0.69	0.70	A15-114	
	Encapsulated	0.26	0.44	0.84	0.98	0.67	0.45	0.72	0.75	A15-115	
3NPA-32 / 3PLNPA-32 ROOF DECK											
Poly-Iso	Plain	0.47	0.61	1.08	1.03	0.83	0.67	0.90	0.90	A22-125	
	Encapsulated	0.52	0.71	1.12	0.80	0.62	0.45	0.83	0.80	A22-188	
3NPA-24 / 3PLNPA-24 ROOF DECK											
Poly-Iso	Plain	0.39	0.56	1.05	0.91	0.67	0.61	0.81	0.80	A19-386	
	Encapsulated	0.39	0.62	1.19	0.74	0.66	0.44	0.80	0.80	A15-231	

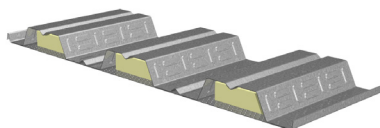

- 2VLPA-36 / 2PLVLPA-36 COMPOSITE DECK

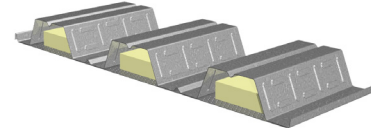

- 3VLPA-36 / 3PLVLPA-36 COMPOSITE DECK

Floor	AC Insulation	Absorption Coefficients						SSA	NRC	Test. No.
		125 Hz	250 Hz	500 Hz	1000 Hz	2000 Hz	4000 Hz			
2VLPA-36 / 2PLVLPA-36 COMPOSITE DECK										
Concrete	Plain	0.31	0.44	0.72	0.77	0.47	0.47	0.60	0.60	A15-120
	Encapsulated	0.39	0.45	0.87	0.66	0.31	0.19	0.58	0.55	A15-119
3VLPA-36 / 3PLVLPA-36 COMPOSITE DECK										
Concrete	Plain	0.48	0.56	1.00	0.75	0.49	0.49	0.69	0.70	A15-121
	Encapsulated	0.51	0.63	0.83	0.49	0.39	0.28	0.58	0.60	A15-122

Note:

1. Factory installed plain 3.0 pcf (48 kg/m³) fiberglass acoustical insulation standard for all cellular decks. Inquire regarding lead time for encapsulated insulation.

NOTICE: Design defects that could cause injury or death may result from relying on the information in this document without independent verification by a qualified professional. The information in this document is provided "AS IS". Nucor Corporation and its affiliates expressly disclaim: (i) any and all representations, warranties and conditions and (ii) all liability arising out of or related to this document and the information in it.

2.0D DOVETAIL FORMLOK® DECK-SLAB ACOUSTICAL SOLUTIONS

ACHIEVE QUIET SPACES WITH PREMIUM FINISHES BY USING THE SUPERIOR STC AND IIC RATINGS OF 2.0D FORMLOK DECK-SLABS

2.0D FORMLOK DECK-SLAB

- 2" (51 mm) Deep Composite Deck
- 5½" (140 mm) Total Slab Depth
- Normal Weight Concrete (145 pcf / 2325 kg/m³)
- Exposed Deck Ceiling

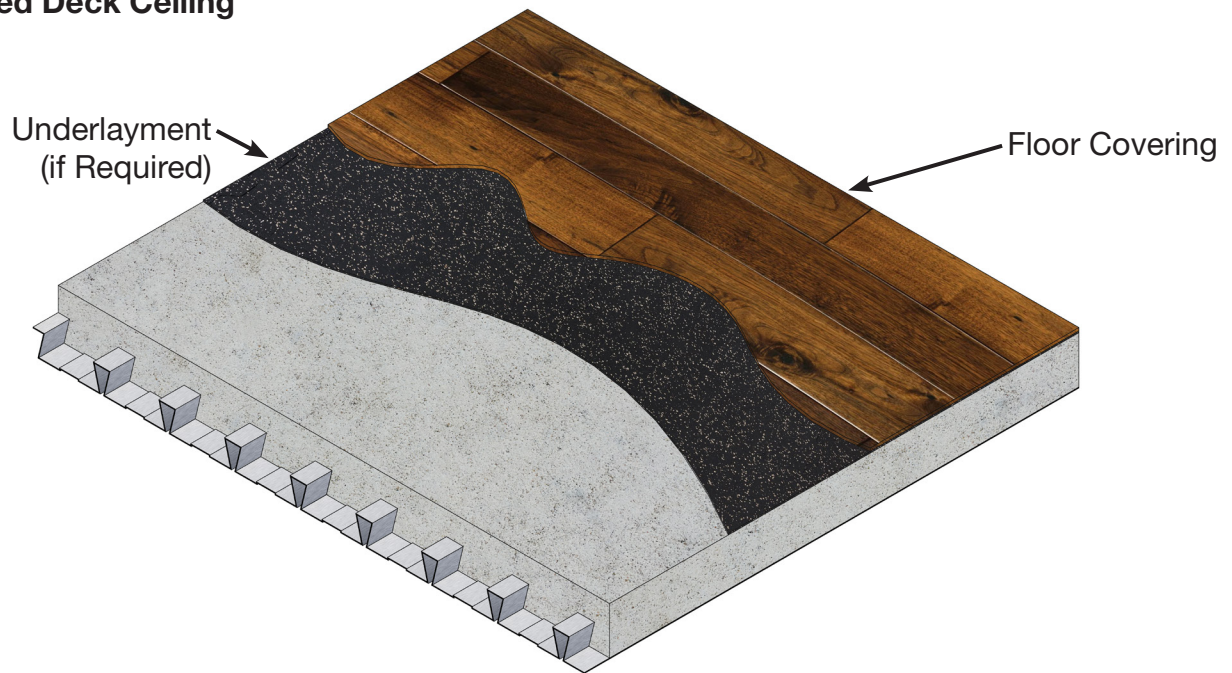

Exposed Deck (No Ceiling)

Floor Covering	Underlayment	STC	IIC	Intertek Test No.
Ceramic Tile	5 mm ECOsilence	51	41	H7786.06
Engineered Wood	5 mm ECOsilence	50	50	H7786.05
Fusion Hybrid Vinyl Plank	2 mm ECOsilence	46	51	H7786.02
Attain Luxury Vinyl Tile	5 mm ECOsilence	52	51	H7786.03
Forest Rx Rubber Backed Sheet Vinyl	None	51	51	H7786.04
Exposed Concrete	None	52	23	H7786.01

2.0D DOVETAIL FORMLOK® DECK-SLAB ACOUSTICAL SOLUTIONS

2.0D FORMLOK DECK-SLAB

- 2" (51 mm) Deep Composite Deck
- 5½" (140 mm) Total Slab Depth
- Normal Weight Concrete (145 pcf / 2325 kg/m³)
- Gypsum Board Ceiling

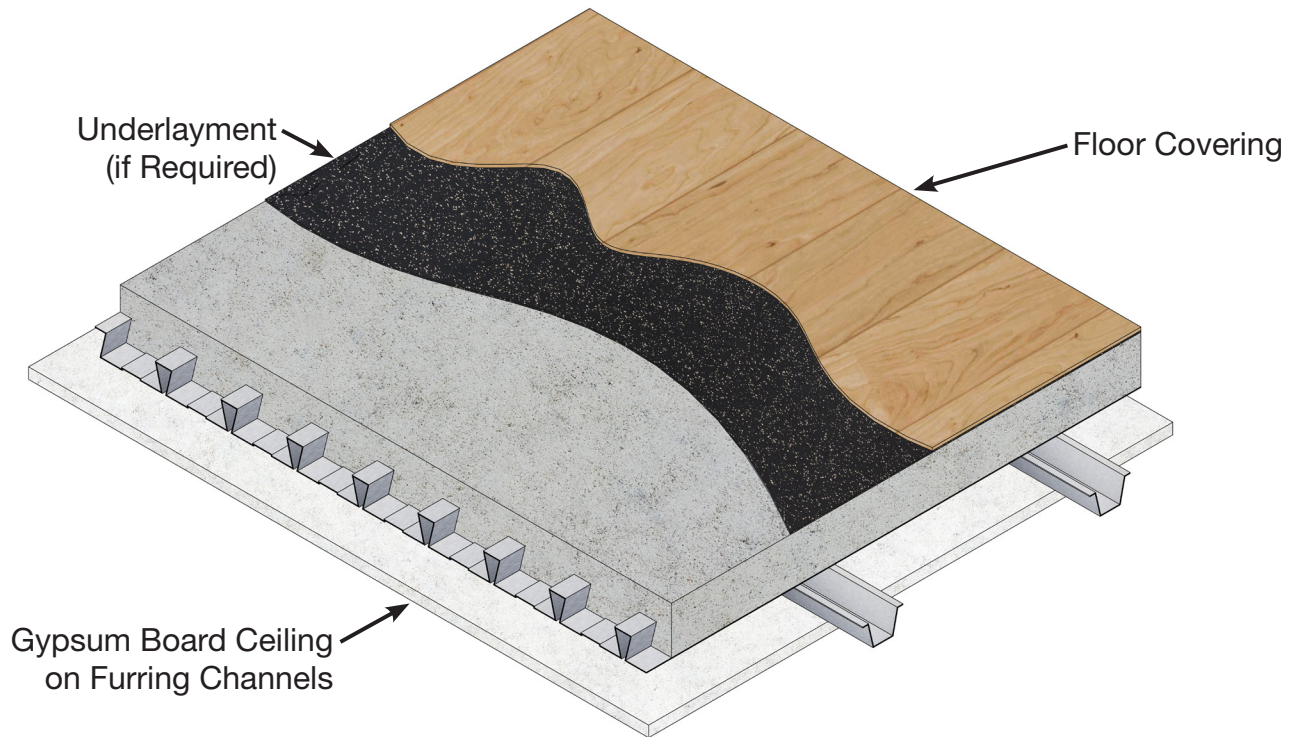

Gypsum Board Ceiling on Furring Channels Directly Attached to Deck

Floor Covering	Underlayment	STC	IIC	Intertek Test No.
Ceramic Tile	5 mm ECOsilence	53	47	H7786.12
Engineered Wood	5 mm ECOsilence	50	50	H7786.11
Fusion Hybrid Vinyl Plank	2 mm ECOsilence	51	50	H7786.08
Attain Luxury Vinyl Tile	2 mm ECOsilence	52	50	H7786.09
Forest Rx Rubber Backed Sheet Vinyl	None	50	50	H7786.10
Exposed Concrete	None	52	32	H7786.07

Note:

1. Values shown are for gypsum board on furring channels directly connected to the underside of the slab. Gypsum board ceilings attached to the deck by methods providing acoustical separation will provide improved STC and IIC values.

2.0D DOVETAIL FORMLOK® DECK-SLAB ACOUSTICAL SOLUTIONS

2.0D FORMLOK DECK-SLAB

- 2" (51 mm) Deep Composite Deck
- 5½" (140 mm) Total Slab Depth
- Normal Weight Concrete (145 pcf / 2325 kg/m³)
- Suspended Gypsum Board Ceiling

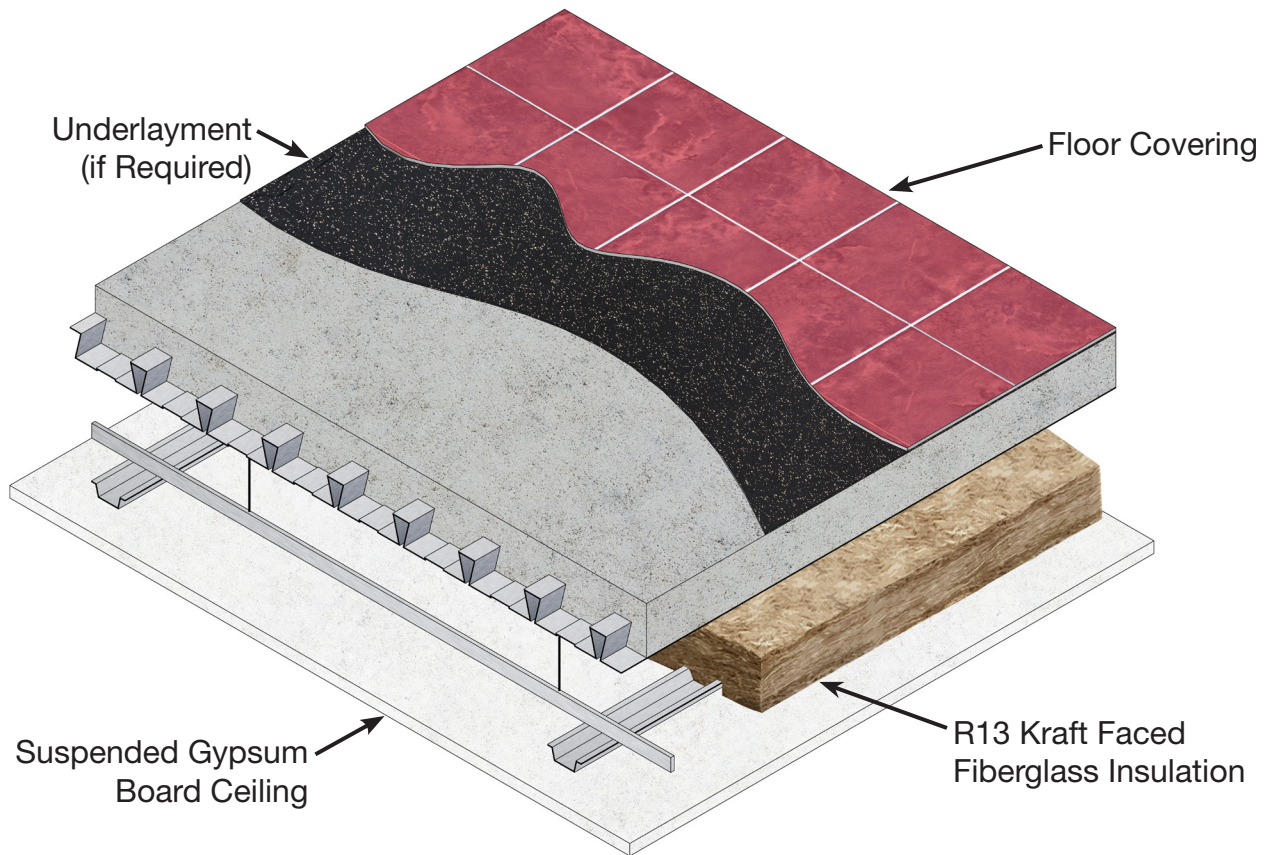

Suspended Gypsum Board Ceiling

Floor Covering	Underlayment	STC	IIC	Intertek Test No.
Ceramic Tile	5 mm ECOsilence	62	60	I5133.01

Note:

1. Laboratory tests determining STC and IIC for Dovetail FormLok deck with a suspended ceiling were conducted with ceramic tile and underlayment. Adding a suspended ceiling to the ceramic tile assembly improved the STC rating by 11 and the IIC rating by 19 compared to an assembly with no ceiling. Other flooring types can expect similar improvement in performance.

2.0D DOVETAIL FORMLOK® DECK-SLAB

Notes:

1. The acoustical test reports with complete assembly details are available from www.dovetaildeck.com.
2. The testing was performed in accordance with the following standards:
 - **ASTM E90-09 (2016)**, *Standard Test Method for Laboratory Measurement of Airborne Sound Transmission Loss of Building Partitions*
 - **ASTM E492-09(2016)e1**, *Standard Test Method for Laboratory Measurement of Impact Sound Transmission Through Floor-Ceiling Assemblies Using the Tapping Machine*

NOTICE: Design defects that could cause injury or death may result from relying on the information in this document without independent verification by a qualified professional. The information in this document is provided "AS IS". Nucor Corporation and its affiliates expressly disclaim: (i) any and all representations, warranties and conditions and (ii) all liability arising out of or related to this document and the information in it.

3.5D DOVETAIL FORMLOK® DECK-SLAB ACOUSTICAL SOLUTIONS

ACHIEVE QUIET SPACES WITH PREMIUM FINISHES BY USING THE SUPERIOR STC AND IIC RATINGS OF 3.5D FORMLOK DECK-SLABS

3.5D FORMLOK DECK-SLAB

- 3½" (89 mm) Deep Composite Deck
- 6" (152 mm) Total Slab Depth
- Normal Weight Concrete (145 pcf / 2325 kg/m³)
- Exposed Deck Ceiling

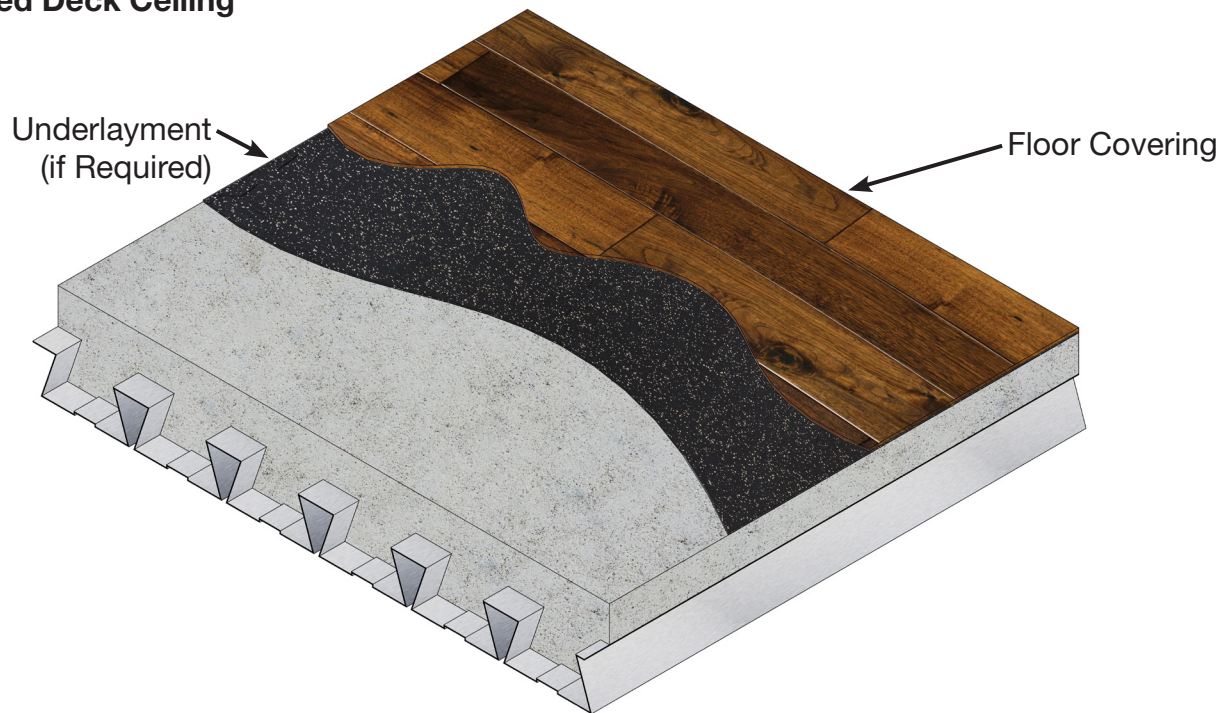

Exposed Deck (No Ceiling)

Floor Covering	Underlayment	STC	IIC	Intertek Test No.
Ceramic Tile	5 mm ECOsilence	50	42	H7787.06
Engineered Wood	5 mm ECOsilence	45	46	H7787.05
Fusion Hybrid Vinyl Plank	2 mm ECOsilence	47	47	H7787.02
Attain Luxury Vinyl Tile	5 mm ECOsilence	50	50	H7787.03
Forest Rx Rubber Backed Sheet Vinyl	None	49	49	H7787.04
Exposed Concrete	None	50	24	H7787.01

3.5D DOVETAIL FORMLOK® DECK-SLAB ACOUSTICAL SOLUTIONS

3.5D FORMLOK DECK-SLAB

- 3½" (89 mm) Deep Composite Deck
- 6" (152 mm) Total Slab Depth
- Normal Weight Concrete (145 pcf / 2325 kg/m³)
- Gypsum Board Ceiling

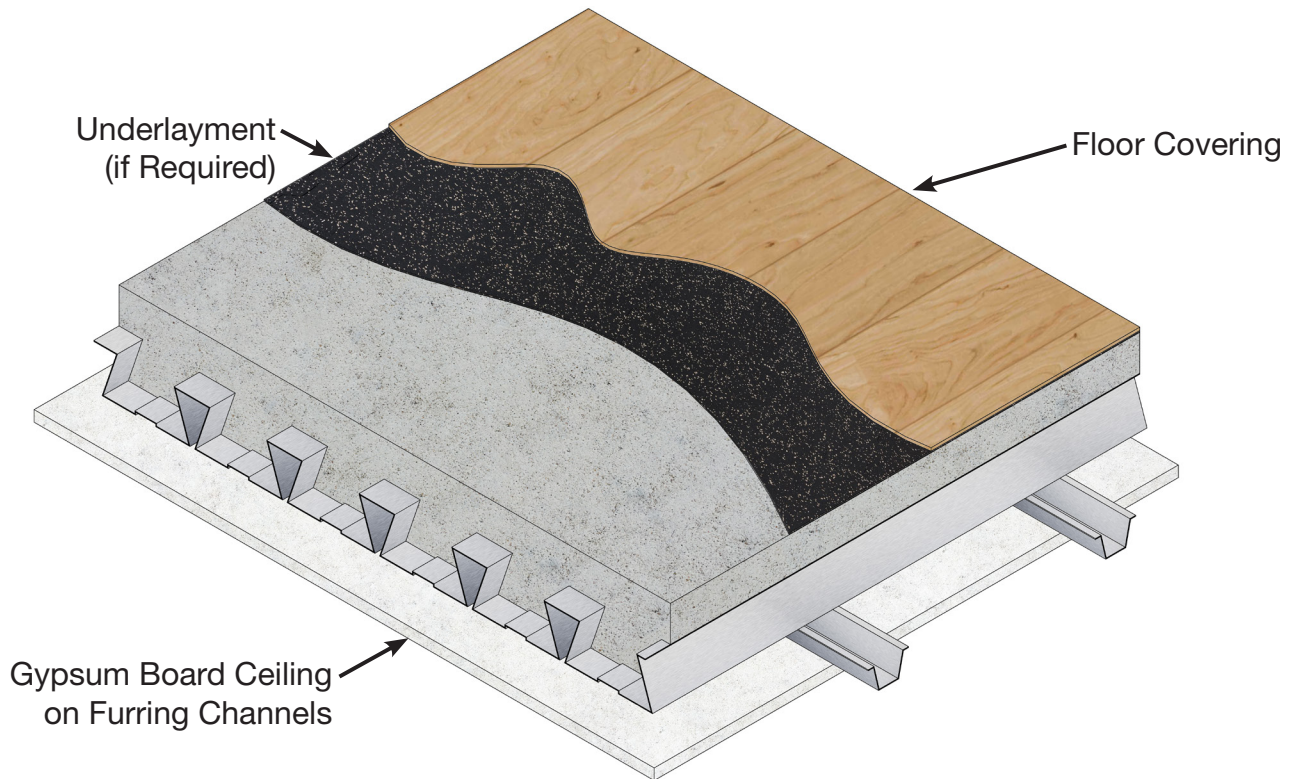

Gypsum Board Ceiling on Furring Channels Directly Attached to Deck

Floor Covering	Underlayment	STC	IIC	Intertek Test No.
Ceramic Tile	5 mm ECOsilence	56	49	H7787.12
Engineered Wood	5 mm ECOsilence	55	52	H7787.11
Fusion Hybrid Vinyl Plank	2 mm ECOsilence	55	53	H7787.08
Attain Luxury Vinyl Tile	5 mm ECOsilence	56	52	H7787.09
Forest Rx Rubber Backed Sheet Vinyl	None	55	52	H7787.10
Exposed Concrete	None	55	32	H7787.07

Note:

1. Values shown are for gypsum board on furring channels directly connected to the underside of the slab. Gypsum board ceilings attached to the deck by methods providing acoustical separation will provide improved STC and IIC values.

3.5D DOVETAIL FORMLOK® DECK-SLAB ACOUSTICAL SOLUTIONS

3.5D FORMLOK DECK-SLAB

- 3½" (89 mm) Deep Composite Deck
- 6" (152 mm) Total Slab Depth
- Normal Weight Concrete (145 pcf / 2325 kg/m³)
- Suspended Gypsum Board Ceiling

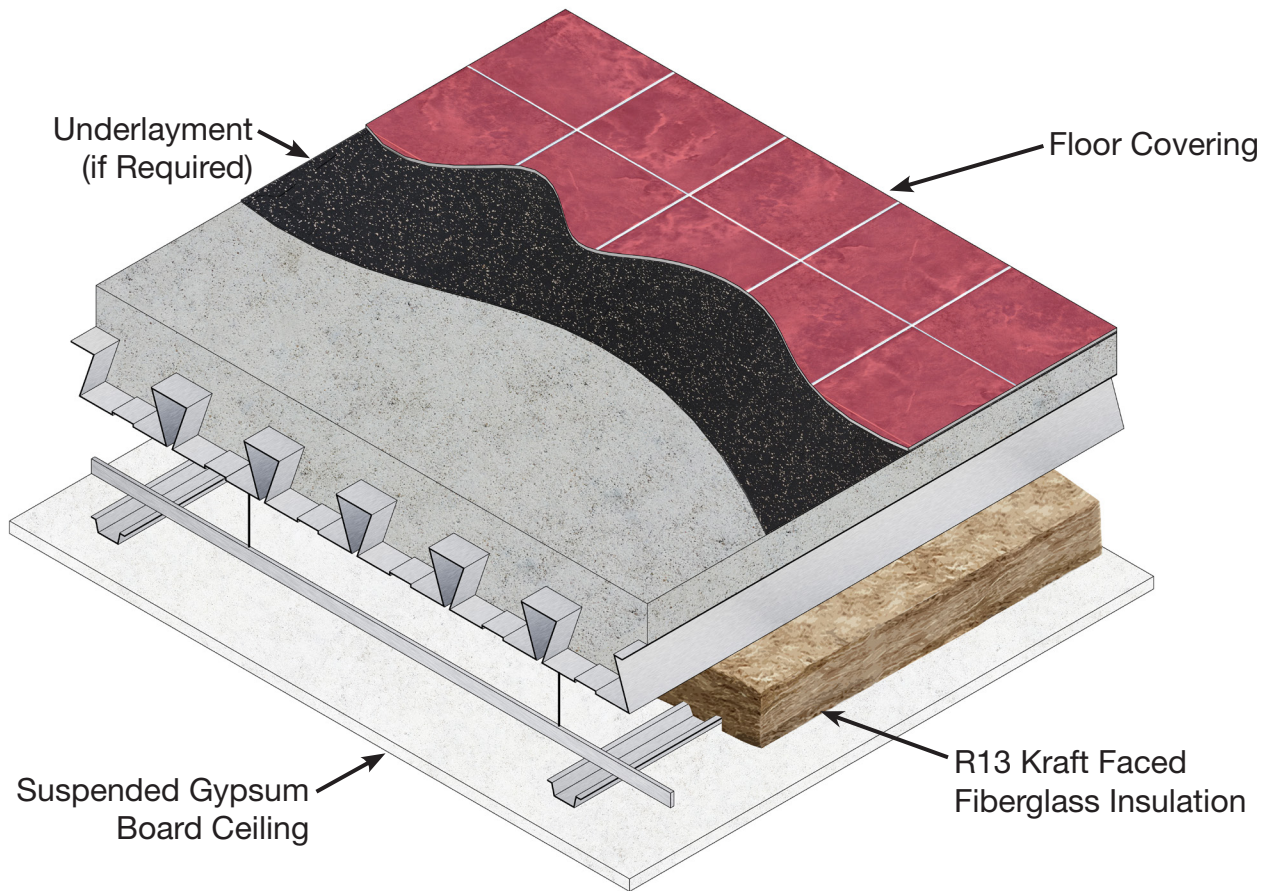

Suspended Gypsum Board Ceiling

Floor Covering	Underlayment	STC	IIC	Intertek Test No.
Ceramic Tile	5 mm ECOsilence	62	62	I5133.02

Note:

1. Laboratory tests determining STC and IIC for Dovetail FormLok deck with a suspended ceiling were conducted with ceramic tile and underlayment. Adding a suspended ceiling to the ceramic tile assembly improved the STC rating by 12 and the IIC rating by 20 compared to an assembly with no ceiling. Other flooring types can expect similar improvement in performance.

3.5D DOVETAIL FORMLOK® DECK-SLAB

Notes:

1. The acoustical test reports with complete assembly details are available from www.dovetaildeck.com.
2. The testing was performed in accordance with the following standards:
 - **ASTM E90-09 (2016)**, *Standard Test Method for Laboratory Measurement of Airborne Sound Transmission Loss of Building Partitions*
 - **ASTM E492-09(2016)e1**, *Standard Test Method for Laboratory Measurement of Impact Sound Transmission Through Floor-Ceiling Assemblies Using the Tapping Machine*

NOTICE: Design defects that could cause injury or death may result from relying on the information in this document without independent verification by a qualified professional. The information in this document is provided "AS IS". Nucor Corporation and its affiliates expressly disclaim: (i) any and all representations, warranties and conditions and (ii) all liability arising out of or related to this document and the information in it.

USE UL RECOGNIZED VULCRAFT ROOF DECKS FOR YOUR FIRE RATED ASSEMBLIES

- Vulcraft steel decks may be used in assemblies which are required to meet hourly fire ratings. Approved hourly fire rated assemblies are a combination of specific proprietary materials as listed in UL fire resistance ratings.

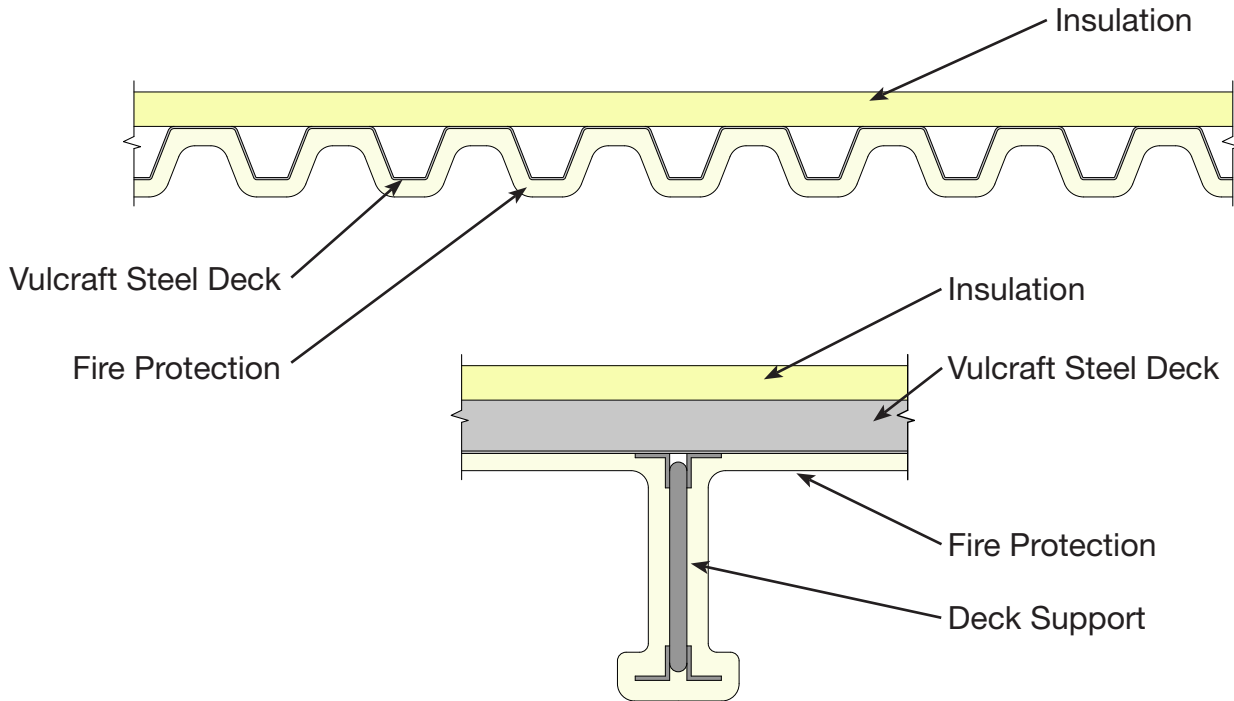

REPRESENTATIVE FIRE RATED ASSEMBLY

Refer to the table on the following pages for a listing of UL fire-rated assemblies utilizing Vulcraft steel deck profiles. Refer to the particular UL assembly being considered for full details of construction, including specific information about fill or fireproofing thicknesses and span limitations.

UL Fire Resistance Ratings

Restrained Assembly Ratings (hr.)	Type of Protection	Type of Insulation	UL Design No.	Deck Type					Unrestrained Beam Rating (hr.)	
				B	32" 3N	24" 3N	2.0D	3.5D		
1	Exposed Grid	Rigid Insulation	P211+	✓						
			P214+	✓					1	
			P225+	✓	✓	✓			1, 1½	
			P227+	✓						
			P230+	✓					1, 1½	
			P235+	✓					1	
			Insulating Fill	P214+	✓					1
	Gypsum Board	Rigid Insulation	P510+	✓	✓	✓				
			P514	✓						
	Cementitious	Rigid Insulation	P701*	✓	✓	✓			1, 1½, 2	
			P711*	✓	✓	✓			1, 1½, 2	
			P717*	✓	✓	✓			1, 1½, 2	
	Sprayed Fiber	Rigid Insulation	P801*	✓	✓	✓			1, 1½, 2, 3	
			P815*	✓	✓	✓			1, 1½, 2, 3	
			P819*	✓	✓	✓			1, 1½, 2	
	Unprotected Deck	Insulating Fill	P902	✓	✓	✓			1, 1½, 2	
			P907	✓	✓	✓			1, 1½, 2	
			P908	✓	✓	✓	✓	✓	1, 1½, 2	
			P919	✓	✓	✓			1, 1½	
			P920	✓	✓	✓			1, 1½, 2	
			P921	✓	✓	✓	✓	✓	1, 1½, 2	
			P922	✓	✓	✓			1, 1½, 2	
			P923	✓	✓	✓			1, 1½, 2	
			P937				✓	✓		
P938						✓	✓	1, 1½, 2		
1½	Exposed Grid	Rigid Insulation	P225+	✓	✓	✓			1, 1½	
			P227+	✓					1, 1½	
			P230+	✓					1, 1½	
	Metal Lath	Rigid Insulation	P404+	✓						
	Gypsum Board	Rigid Insulation	P510+	✓	✓	✓				
			P701*	✓	✓	✓			1, 1½, 2	
	Cementitious	Rigid Insulation	P711*	✓	✓	✓			1, 1½, 2	
			P717*	✓	✓	✓			1, 1½, 2	

UL Fire Resistance Ratings (continued)

Restrained Assembly Ratings (hr.)	Type of Protection	Type of Insulation	UL Design No.	Deck Type					Unrestrained Beam Rating (hr.)
				B	32" 3N	24" 3N	2.0D	3.5D	
1½	Sprayed Fiber	Rigid Insulation	P801*	✓	✓	✓			1,1½,2
			P815*	✓	✓	✓			1,1½,2,3
			P819*	✓	✓	✓			1,1½,2,3
	Unprotected Deck	Insulating Fill	P902	✓	✓	✓			1,1½,2
			P907	✓	✓	✓			1,1½,2
			P908	✓	✓	✓	✓	✓	1,1½,2
			P919	✓	✓	✓			1,1½
			P920	✓	✓	✓			1,1½,2
			P921	✓	✓	✓	✓	✓	1,1½,2
			P922	✓	✓	✓			1,1½,2
			P923	✓	✓	✓			1,1½,2
			P937				✓	✓	
			P938				✓	✓	1,1½,2
2	Exposed Grid	Rigid Insulation	P237+	✓					2
	Metal Lath	Rigid Insulation	P404+	✓					
	Gypsum Board	Rigid Insulation	P514+	✓					
	Cementitious	Rigid Insulation	P701*	✓	✓	✓			1,1½,2
			P711*	✓	✓	✓			1,1½,2
			P717*	✓	✓	✓			1,1½,2
	Sprayed Fiber	Rigid Insulation	P801*	✓	✓	✓			1,1½,2
			P815*	✓	✓	✓			1,1½,2
			P819*	✓	✓	✓			1,1½,2,3
	Unprotected Deck	Insulating Fill	P902	✓	✓	✓			1,1½,2
			P907	✓	✓	✓			1,1½,2
			P908	✓	✓	✓	✓	✓	1,1½,2
			P920	✓	✓	✓			1,1½,2
P921			✓	✓	✓	✓	✓	1,1½,2	
P922			✓	✓	✓			1,1½,2	
P923			✓	✓	✓			1,1½,2	
P937						✓	✓		
P938				✓	✓	1,1½,2			

Notes:

1. Refer to the UL “Fire Resistance Directory” for the necessary construction details.
2. Deck finish shall be galvanized unless noted otherwise.
 - + Deck finish is not critical for fire resistance when used in P2--, P4--, & P5-- Series designs. Deck finish shall be galvanized or painted.
 - * Denotes deck finish is critical for fire resistance. Deck finish shall be galvanized or painted. This gray paint is a special type of paint and is compatible with the spray-applied fire protection and is U.L. approved for use in the denoted P7-- & P8-- Series designs.
3. B = 1.5B, 1.5BI, and 1.5PLB
32” 3N = 32” Wide 3NL, 3NI, and 3PLN
24” 3N = 24” Wide 3N and 3NI

NOTICE: Design defects that could cause injury or death may result from relying on the information in this document without independent verification by a qualified professional. The information in this document is provided “AS IS”. Nucor Corporation and its affiliates expressly disclaim: (i) any and all representations, warranties and conditions and (ii) all liability arising out of or related to this document and the information in it.

VULCRAFT® COMPOSITE & NON-COMPOSITE DECK UL FIRE RATED ASSEMBLIES

USE UL RECOGNIZED COMPOSITE AND NON-COMPOSITE DECKS FOR YOUR FIRE RATED ASSEMBLIES WITH STRUCTURAL CONCRETE FILL

- Vulcraft composite and non-composite slabs may be used to meet hourly fire ratings. The type and thickness of concrete specified will generally determine whether fireproofing will be required on the underside of the composite or non-composite deck.

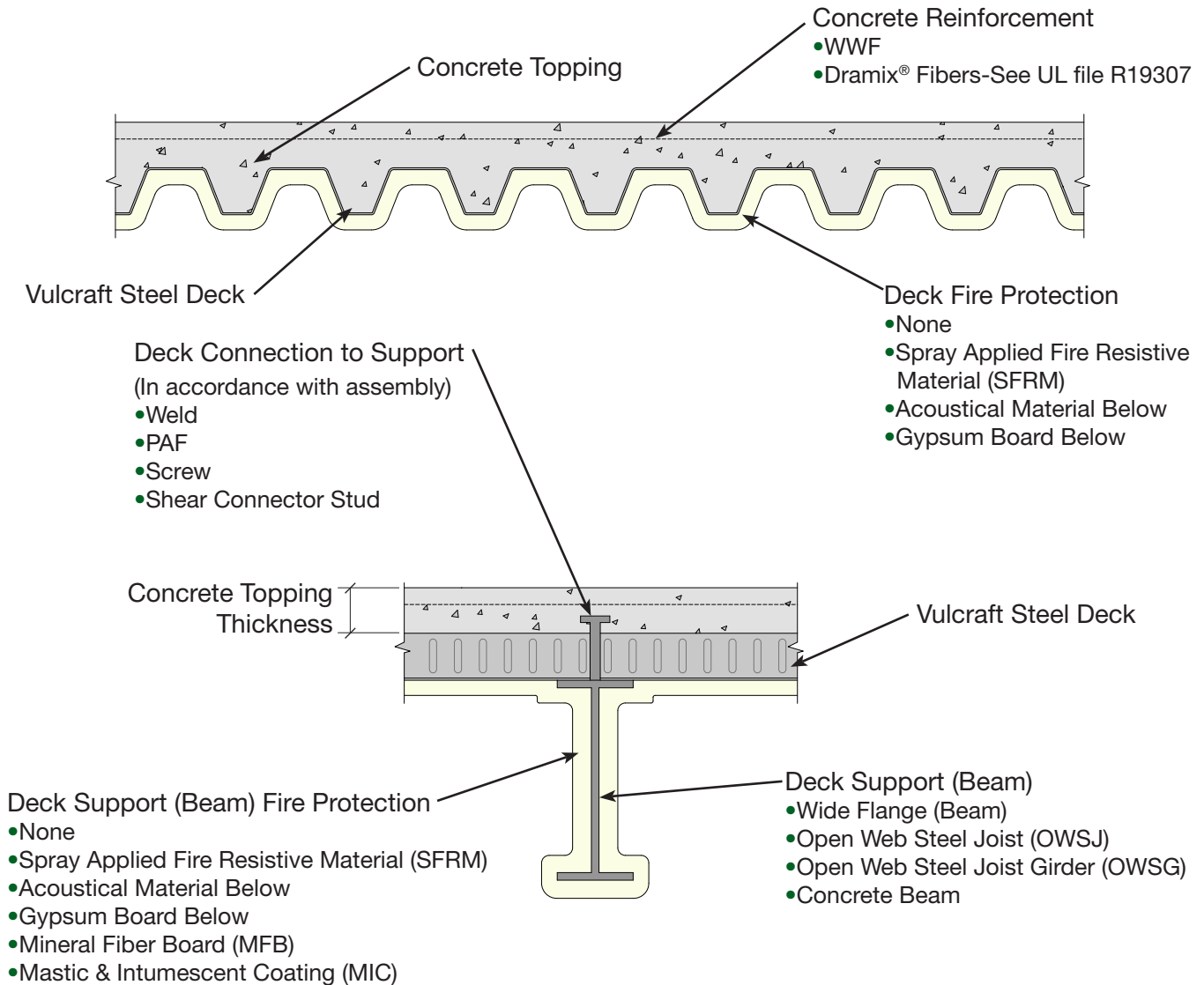

REPRESENTATIVE FIRE RATED ASSEMBLY

The table on the following pages lists the UL fire rated assemblies that include Vulcraft composite and non-composite decks profiles. This summary table is provided to assist in identification of assemblies to meet specific project requirements. Refer to the particular UL assembly for full details of construction including, specific information about concrete slab, framing, type of fire protection, deck types and span limitations.

VULCRAFT® COMPOSITE DECK

UL FIRE RATED ASSEMBLIES



UL Fire Resistance Ratings

Restrained Assembly Ratings (hr.)	Type of Protection	Concrete Thickness & Type	UL Design No.	Deck Type						Unrestrained Beam Rating (hr.)
				1.5VL	2VL	3VL	1.5VLP	2VLP	3VLP	
3/4	Unprotected Deck	2 1/2" LW	D914 #	✓	✓	✓	✓	✓	✓	1
			D916 #	✓	✓	✓	✓	✓	✓	1, 1 1/2, 2, 3
1	Exposed Grid	2 1/2" NW	D216 +	✓	✓	✓		✓	✓	2, 3
		2" NW & LW	D743 *		✓	✓		✓	✓	1, 1 1/2, 2, 3
	Cementitious	2 1/2" NW & LW	D703 *	✓	✓	✓	✓	✓	✓	1 1/2
			D712 *		✓	✓			✓	2
			D722 *		✓	✓		✓	✓	1, 1 1/2, 2
			D739 *	✓	✓	✓	✓	✓	✓	1, 1 1/2, 2, 3, 4
			D759 *	✓	✓	✓	✓	✓	✓	1, 1 1/2, 2, 3
			D859 *		✓	✓		✓	✓	1, 1.5, 2, 3
	Sprayed Fiber	2 1/2" NW & LW	D832 *	✓	✓	✓	✓	✓	✓	1, 1 1/2, 2, 3
			D847 *		✓	✓		✓	✓	1, 1 1/2, 3
			D858 *		✓	✓		✓	✓	1, 1 1/2, 2, 3, 4
			D871 *		✓	✓		✓	✓	1, 1 1/2, 2, 3
D902 #			✓	✓	✓	✓	✓	✓	1, 1 1/2, 2, 3	
Unprotected Deck	2 1/2" LW	D914 #	✓	✓	✓	✓	✓	✓	1	
		D916 #	✓	✓	✓	✓	✓	✓	1, 1 1/2, 2, 3	
		D919 #	✓	✓	✓	✓	✓	✓	1, 1 1/2	
	3 1/2" NW	D902 #	✓	✓	✓	✓	✓	✓	1, 1 1/2, 2, 3	
		D916 #	✓	✓	✓	✓	✓	✓	1, 1 1/2, 2, 3	
		D919 #	✓	✓	✓	✓	✓	✓	1, 1 1/2	
1 1/2	Gypsum Board	2 1/2" NW	D502 *	✓	✓	✓		✓	✓	1 1/2, 2
		2" NW & LW	D743 *		✓	✓		✓	✓	1, 1 1/2, 2, 3
	Cementitious	2 1/2" NW & LW	D703 *	✓	✓	✓	✓	✓	✓	1 1/2
			D712 *		✓	✓			✓	2
			D722 *		✓	✓		✓	✓	1, 1 1/2, 2
			D739 *	✓	✓	✓	✓	✓	✓	1, 1 1/2, 2, 3, 4
			D759 *	✓	✓	✓	✓	✓	✓	1, 1 1/2, 2, 3

✓⁺ 1.5VLI Only

(continued on next page)

VULCRAFT® COMPOSITE DECK

UL FIRE RATED ASSEMBLIES



UL Fire Resistance Ratings (continued)

Restrained Assembly Ratings (hr.)	Type of Protection	Concrete Thickness & Type	UL Design No.	Deck Type						Unrestrained Beam Rating (hr.)	
				1.5VL	2VL	3VL	1.5VLP	2VLP	3VLP		
1½	Sprayed Fiber	2" NW & LW	D859 *		✓	✓		✓	✓	1,1½,2,3	
			D832 *	✓	✓	✓	✓	✓	✓	1,1½,2,3	
		2½" NW & LW	D847 *		✓	✓		✓	✓	1,1½,3	
			D858 *		✓	✓		✓	✓	1,1½,2,3,4	
			D871 *		✓	✓		✓	✓	1,1½,2,3	
	Unprotected Deck	3" LW	D902 #	✓	✓	✓	✓	✓	✓	1,1½,2,3	
			D916 #	✓	✓	✓	✓	✓	✓	1,1½,2,3	
		4" NW	D919 #	✓	✓	✓	✓	✓	✓	1,1½	
			D902 #	✓	✓	✓	✓	✓	✓	1,1½,2,3	
			D916 #	✓	✓	✓	✓	✓	✓	1,1½,2,3	
	D919 #	✓	✓	✓	✓	✓	✓	1,1½			
	Exposed Grid	2½" NW	D216 +	✓	✓	✓		✓	✓	2,3	
	Gypsum Board	2½" NW	D502 +	✓	✓	✓		✓	✓	1½,2	
	2	Cementitious	2" NW & LW	D743 *		✓	✓		✓	✓	1,1½,2,3
				D746 *	✓						1,1½,2,3
2½" LW			D752 *	✓	✓	✓	✓	✓	✓	1,1½,2,	
			D703 *	✓	✓	✓	✓	✓	✓	1½	
			D712 *		✓	✓			✓	2	
2½" NW & LW		D716 *	✓	✓	✓		✓	✓	1½,2		
		D722 *		✓	✓		✓	✓	1,1½,2		
		D739 *		✓	✓	✓	✓	✓	1,1½,2,3,4		
		D745 *		✓	✓				1,1½,2		
		D750 *	✓	✓	✓				1½,2		
		D755*	✓	✓	✓	✓	✓	✓	1,1½,2,3		
		D759*	✓	✓	✓	✓	✓	✓	1,1½,2,3		
		D760 *	✓+	✓	✓				1,1½,2,3,4		
2½" NW		D730 *		✓	✓		✓	✓			
		D742 *	✓	✓	✓				1,1½		

✓+ 1.5VLI Only

(continued on next page)

VULCRAFT® COMPOSITE DECK UL FIRE RATED ASSEMBLIES



UL Fire Resistance Ratings (continued)

Restrained Assembly Ratings (hr.)	Type of Protection	Concrete Thickness & Type	UL Design No.	Deck Type						Unrestrained Beam Rating (hr.)	
				1.5VL	2VL	3VL	1.5VLP	2VLP	3VLP		
2	Sprayed Fiber	2" NW & LW	D859 *		✓	✓			✓	✓	1,1½,2,3
			D822 *		✓	✓			✓	✓	1
			D825 *	✓	✓	✓			✓	✓	1,1½,2
		D831 *		✓	✓			✓	✓	1,1½,2	
		D832 *	✓	✓	✓	✓		✓	✓	1,1½,2,3	
		2½" NW & LW	D833 *	✓	✓	✓			✓	✓	1½
			D847 *		✓	✓			✓	✓	1,1½,3
			D858 *		✓	✓			✓	✓	1,1½,2,3,4
			D861 *		✓	✓					1,1½
		D871 *		✓	✓			✓	✓	1,1½,2,3	
	2½" LW	D862 *		✓	✓					1	
		¾" LW	D860 *		✓	✓					1,1½,2
	Unprotected Deck		3¼" LW	D826 #	✓	✓	✓	✓		✓	✓
		D840 #		✓	✓	✓	✓		✓	✓	1,1½
		D902 #		✓	✓	✓	✓		✓	✓	1,1½,2,3
		¾" LW	D907 #	✓	✓	✓	✓		✓	✓	1,2
			D913 #	✓	✓	✓	✓		✓	✓	1
			D916 #	✓	✓	✓	✓		✓	✓	1,1½,2,3
			D919 #	✓	✓	✓	✓		✓	✓	1,1½
		D920 #		✓	✓			✓	✓	1½	
4½" NW		D902 #	✓	✓	✓	✓		✓	✓	1,1½,2,3	
		D916 #	✓	✓	✓	✓		✓	✓	1,1½,2,3	
	D919 #	✓	✓	✓	✓		✓	✓	1,1½		

✓⁺ 1.5VLI Only

(continued on next page)

VULCRAFT® COMPOSITE DECK

UL FIRE RATED ASSEMBLIES



UL Fire Resistance Ratings (continued)

Restrained Assembly Ratings (hr.)	Type of Protection	Concrete Thickness & Type	UL Design No.	Deck Type						Unrestrained Beam Rating (hr.)	
				1.5VL	2VL	3VL	1.5VLP	2VLP	3VLP		
3	Exposed Grid	3¼" NW	D216 +	✓	✓	✓		✓	✓	2,3	
		2" NW & LW	D743 *		✓	✓		✓	✓	1,1½,2,3	
		2½" LW	D746 *	✓						1,1½,2,3	
	Cementitious	2½" NW & LW		D703 *	✓	✓	✓	✓	✓	✓	1½
				D708 *	✓+	✓	✓	✓	✓	✓	1½,3
				D739 *	✓	✓	✓	✓	✓	✓	1,1½,2,3,4
				D755	✓	✓	✓	✓	✓	✓	1,1½,2,3
				D759	✓	✓	✓	✓	✓	✓	1,1½,2,3
				D760 *	✓+	✓	✓				1,1½,2,3,4
				D754 *	✓	✓	✓				1½,2
		3¼" LW	D754 *	✓	✓	✓				1½,2	
		3¼" NW	D742 *	✓	✓	✓				1,1½	
		2" NW & LW	D859 *		✓	✓		✓	✓	1,1½,2,3	
			D816 *	✓	✓	✓		✓	✓	1½,2	
			D831 *		✓	✓		✓	✓	1,1½,2	
		Sprayed Fiber	2½" NW & LW	D832 *	✓	✓	✓	✓	✓	✓	1,1½,2,3
	D833 *			✓	✓	✓		✓	✓	1½	
	D858*				✓	✓		✓	✓	1,1½,2,3,4	
	D871 *				✓	✓		✓	✓	1,1½,2,3	
		3¼" LW	D860 *		✓	✓				1,1½,2	
		Unprotected Deck	5¼" NW	D902 #	✓	✓	✓	✓	✓	✓	1,1½,2,3
	D916 #			✓	✓	✓	✓	✓	✓	1,1½,2,3	
	D919 #			✓	✓	✓	✓	✓	✓	1,1½	
	D902 #			✓	✓	✓	✓	✓	✓	1,1½,2,3	
	D916 #			✓	✓	✓	✓	✓	✓	1,1½,2,3	
		D919 #	✓	✓	✓	✓	✓	✓	1,1½		
4	Cementitious	2½" NW & LW	D760 *	✓+	✓	✓				1,1½,2,3,4	
			D739 *	✓	✓	✓	✓	✓	✓	1,1½,2,3,4	
			D754 *	✓	✓	✓				1½,2	
	Sprayed Fiber	2½" NW & LW	D858 *		✓	✓		✓	✓	1,1½,2,3,4	
			D860 *		✓	✓				1,1½,2	

✓+ 1.5VLI Only

(continued on next page)

VULCRAFT® NON-COMPOSITE DECK UL FIRE RATED ASSEMBLIES



UL Fire Resistance Ratings

Restrained Assembly Ratings (hr.)	Type of Protection	Concrete Thickness & Type	UL Design No.	Deck Type				Unrestrained Beam Rating (hr.)
				0.6C	1.0C	1.3C	1.5C	
1	Exposed Grid	2½" NW	G256 +	✓	✓	✓	✓	1,2,3
	Cementitious	2½" NW & LW	G701	✓	✓	✓	✓	1,1½,2,3
			G705	✓	✓	✓	✓	1,1½,2,3
	Sprayed Fiber	2¾" NW & LW	G801	✓	✓	✓	✓	1,1½,2
1½	Exposed Grid	2" NW	G229 +	✓	✓	✓	✓	1½,2,3
		2½" NW	G228 +	✓	✓	✓	✓	1½,2
			G243 +	✓	✓	✓	✓	1½,2
			G213 +	✓	✓	✓	✓	1½,2,3
	Gypsum Board	2" NW & LW	G502 +	✓	✓	✓	✓	
	Cementitious	2½" NW & LW	G701	✓	✓	✓	✓	1,1½,2,3
			G705	✓	✓	✓	✓	1,1½,2,3
	Sprayed Fiber	2¾" NW & LW	G801	✓	✓	✓	✓	1,1½,2
2	Exposed Grid	2½" NW	G227 +	✓	✓	✓	✓	2,3
			G228 +	✓	✓	✓	✓	1½,2
			G229 +	✓	✓	✓	✓	1½,2,3
			G243 +	✓	✓	✓	✓	1½,2
			G256 +	✓	✓	✓	✓	1,2,3
			G213 +	✓	✓	✓	✓	1½,2,3
	Gypsum Board	2" NW	G505 +	✓	✓	✓	✓	
		2½" NW & LW	G529 +	✓	✓	✓	✓	2,3
		2½" NW	G514 +	✓	✓	✓	✓	3
			G523 +	✓	✓	✓	✓	2,3
Cementitious	2½" NW & LW	G701	✓	✓	✓	✓	1,1½,2,3	
		G705	✓	✓	✓	✓	1,1½,2,3	
Sprayed Fiber	2¾" NW & LW	G801	✓	✓	✓	✓	1,1½,2	
3	Exposed Grid	3¼" NW	G229 +	✓	✓	✓	✓	1½,2,3
		3½" NW	G213 +	✓	✓	✓	✓	1½,2,3
			G256 +	✓	✓	✓	✓	1½,2,3
	Gypsum Board	3¼" NW & LW	G529 +	✓	✓	✓	✓	2,3
	Cementitious	2¾" NW & LW	G701	✓	✓	✓	✓	1,1½,2,3
			G705	✓	✓	✓	✓	1,1½,2,3
Sprayed Fiber	2¾" NW & LW	G801	✓	✓	✓	✓	1,1½,2	

VULCRAFT® DOVETAIL FORMLOK® DECK

UL FIRE RATED ASSEMBLIES



UL Fire Resistance Ratings

Restrained Assembly Ratings (hr.)	Type of Protection	Concrete Thickness & Type	UL Design No.	Deck Type		Unrestrained Beam Rating (hr.)
				2D	3.5D	
1 ¹⁰	Unprotected Deck	2" LW & 2¾" NW	D904	✓		¾
			D961	✓		¾
			D917	✓		
			D928	✓		¾
1½	Unprotected Deck	2" LW & 2" NW	D947		✓	
			D964		✓	
			D984		✓	
2	Unprotected Deck	2½" LW, 3" SLW & 3¼" NW	D904	✓		1
			D961	✓		1
			D917	✓		¾
			D928	✓		1
		2" LW & 2¼" NW	D506		✓	1
			D947		✓	¾
			D964		✓	¾
			D984		✓	¾
3	Unprotected Deck	3¼" LW, 4" SLW & 4¾" NW	D904	✓		1
			D961	✓		1
			D917	✓		¾
			D928	✓		1
		2¼" LW & 3¾" NW	D947		✓	1½
			D964		✓	1½
			D984		✓	1½

VULCRAFT® COMPOSITE & NON-COMPOSITE DECK UL FIRE RATED ASSEMBLIES

Notes:

1. Refer to the UL “Fire Resistance Directory” for the necessary construction details.
2. 1.5VL = 1.5VL, 1.5VLI, and 1.5PLVLI
 2VL = 2VLI, 2VLJ, and 2PLVLI
 3VL = 3VLI, 3VLJ, and 3PLVLI
 1.5VLP = 1.5VLP and 1.5PLVLP
 2VLP = 2VLP, and 2PLVLP
 3VLP = 3VLP, and 3PLVLP
3. Concrete thickness is thickness of slab above deck, in.
4. 1.5VLR may be used in designs D832, D902, and D916.
5. All Dovetail FormLok composite deck assemblies are subject to an upper live load limit of 130 psf.
6. Fluted deck finish shall be galvanized unless noted otherwise.
 - + Denotes fluted deck finish is not critical when used in D2-- & D5-- Series designs. Deck finish shall be galvanized or phosphatized/painted.
 - * Fluted deck finish is critical for fire resistance. Fluted deck finish shall be galvanized or phosphatized/painted. This gray paint is a special type of paint and is compatible with the spray-applied fire protection and is U.L. approved for use in the denoted D7-- & D8-- Series designs.
 - # Denotes fluted deck finish is not critical for fire resistance. Fluted deck finish shall be galvanized or phosphatized/painted.
7. Vulcraft cellular deck used in the listed assemblies shall be galvanized.
8. Vulcraft cellular deck units are approved by UL for use as electrical raceways under UL Standard 209.
9. Dramix® fibers may be used in UL or ULC fire rated assemblies in lieu of WWR. See UL file R19307 for additional information.
10. Restrained Assembly Rating is 1½ hr with listed NW concrete thickness.

Concrete Thickness

(in.)	(mm)
2	51
2½	64
2¾	70
3¼	83
3½	89
4	102
4 ³ / ₁₆	106
4½	114
4¾	121
5¼	133

NOTICE: Design defects that could cause injury or death may result from relying on the information in this document without independent verification by a qualified professional. The information in this document is provided “AS IS”. Nucor Corporation and its affiliates expressly disclaim: (i) any and all representations, warranties and conditions and (ii) all liability arising out of or related to this document and the information in it.

VULCRAFT ROOF DECK SAMMY X-PRESS HANGING SOLUTIONS

HANG AND BRACE YOUR MECHANICAL SYSTEMS FROM VULCRAFT ROOF AND ACOUSTICAL ROOF DECK

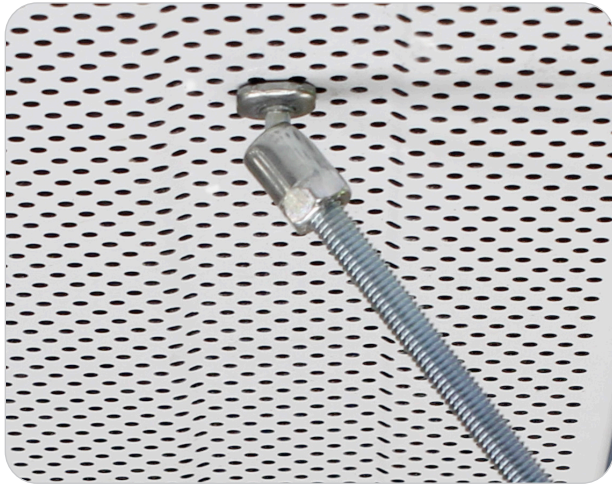

ITW BUILDEX SAMMY X-PRESS CONNECTION STRENGTH

GR50/GR40 DECK

SAMMY X-Press Type				Deck Type			
				Solid		Perforated	
Part Number	Model Number	Rod Size (in.)	Deck Gage	Allowable P_n/Ω (lbs)	Design ϕP_n (lbs)	Allowable P_n/Ω (lbs)	Design ϕP_n (lbs)
8181922	XP 200	1/4	22	328 / 277	521 / 441	229 / 194	359 / 303
8150922	XP 20	3/8	20	398 / 337	634 / 535	278 / 235	435 / 368
8294922	SXP 20	3/8	19	464 / 393	738 / 625	324 / 274	508 / 430
8272957	SXP 2.0	1/2	18	527 / 446	837 / 709	368 / 311	576 / 488
8181922	XP 200	1/4	16	664 / 562	1056 / 894	464 / 392	727 / 615
8153299	XP 35	3/8					
8295922	SXP 35	3/8					
8271957	SXP 3.5	1/2					

Notes:

1. The strength of the steel deck, Sammy X-Press connector, or threaded rod, bolt, and other connecting hardware shall be equal to or greater than the governing load combination as stipulated in the IBC or ASCE/SEI 7.
2. SAMMY X-Press connectors shall be installed per manufacturer's instructions.

VULCRAFT ROOF DECK SAMMY X-PRESS HANGING SOLUTIONS

HANG SPRINKLER PIPES FROM VULCRAFT ROOF AND ACOUSTICAL ROOF DECK



MAXIMUM SPRINKLER PIPE DIAMETER			GR50/GR40 DECK		
SAMMY X-Press Type			Deck Type		
Part Number	Model Number	Rod Size (in.)	Deck Gage	Solid (in.)	Perforated (in.)
8150922	XP 20	3/8	22	2 1/2 / 2	2 / 1 1/2
8294922	SXP 20	3/8	20	2 1/2 / 2 1/2	2 / 2
8272957	SXP 2.0	1/2	19	3 / 2 1/2	2 1/2 / 2
			18	3 1/2 / 3	2 1/2 / 2 1/2
8153299	XP 35	3/8			
8295922	SXP 35	3/8	16	4 / 4	3 1/2 / 3
8271957	SXP 3.5	1/2			



Notes:

1. Maximum fire sprinkler pipe size in accordance with NFPA 13.
2. The strength of the steel deck, Sammy X-Press connector, or threaded rod, bolt, and other connecting hardware shall be equal to or greater than the governing load combination as stipulated in the IBC or ASCE/SEI 7 including the fire sprinkler system loading.
3. SAMMY X-Press connectors shall be installed per manufacturer's instructions.

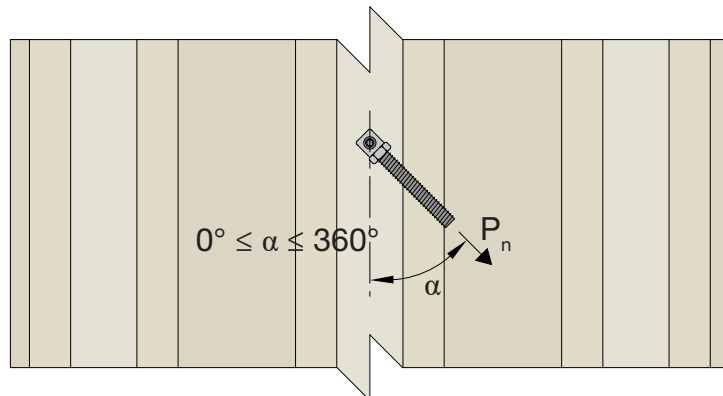
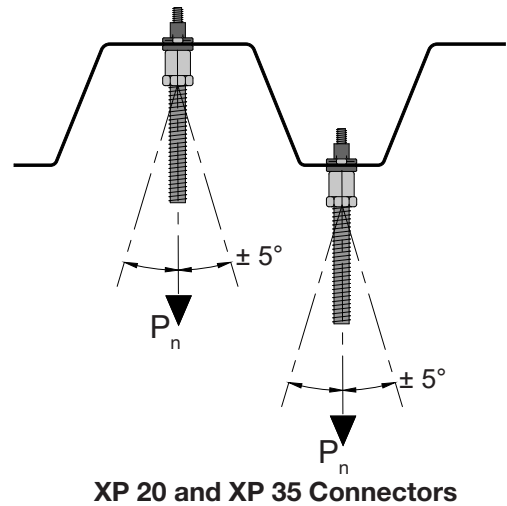
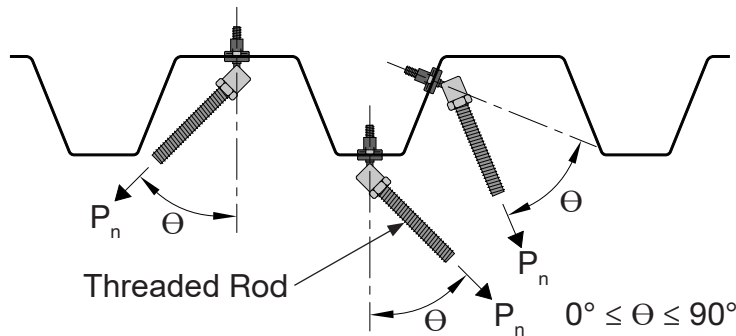

SXP 20, SXP2.0, SXP 35 and SXP 3.5 Connectors

NOTICE: Design defects that could cause injury or death may result from relying on the information in this document without independent verification by a qualified professional. The information in this document is provided "AS IS". Nucor Corporation and its affiliates expressly disclaim: (i) any and all representations, warranties and conditions and (ii) all liability arising out of or related to this document and the information in it.

DOVETAIL FORMLOK® DECK-SLAB WEDGE-NUT HANGING SOLUTIONS

HANG YOUR MECHANICAL SYSTEMS FROM DOVETAIL FORMLOK COMPOSITE DECK-SLABS

DOVETAIL FORMLOK WEDGE-NUTS

- IAPMO UES ER-423
- UL Listed



HANGING LOAD

$f'_c = 2500$ psi (min.) NWC or LWC

Profile	Part Number	Connection Strength	
		Allowable P_n / Ω (lbs)	Design ϕP_n (lbs)
2.0D FormLok	2.0D-WN-3/8NC	1392	2297
	2.0D-WN-1/2NC		
3.5D FormLok	3.5D-WN-3/8NC	1996	3294
	3.5D-WN-1/2NC		

MAXIMUM SPRINKLER PIPE DIAMETER



Profile	Part Number	NPS	UL No.
		Diameter (in.)	
2.0D FormLok	2.0D-WN-3/8NC	4	EX27777
	2.0D-WN-1/2NC	6	
3.5D FormLok	3.5D-WN-3/8NC	4	EX27777
	3.5D-WN-1/2NC	8	

Notes:

1. The strength of the Dovetail FormLok Composite steel deck-slab, Wedge-Nut, or threaded rod, bolt, and other connecting hardware shall be equal or greater than the governing load combination as stipulated in the IBC or ASCE/SEI 7 including the fire sprinkler system loading.
2. Wedge-Nut connections shall be installed per manufacturer's instructions.

DOVETAIL FORMLOK® DECK-SLAB WEDGE-NUT HANGING SOLUTIONS

DOVETAIL FORMLOK WEDGE-NUT INSTALLATION

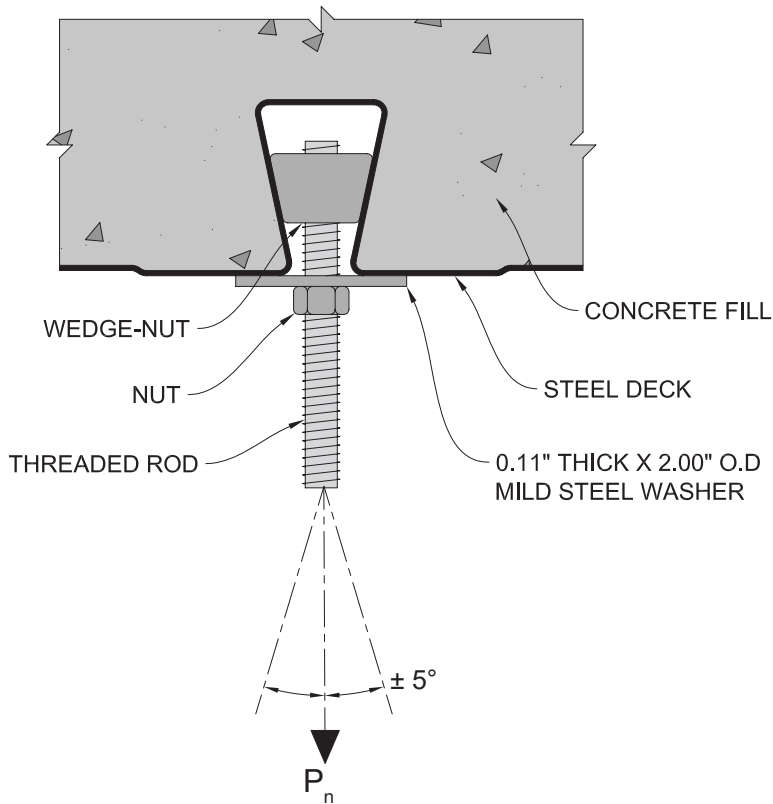

Figure 1

1. Deck ribs shall be free of foreign material to ensure the wedge-nut bears directly on the steel deck.
2. Insert wedge-nut and rotate to seat the surface against the webs of the steel deck as shown in Figure 1.
3. Position wedge-nut in the center of the rib with the threaded rod or bolt perpendicular to the bottom surface of the steel deck as shown in Figure 1.
4. Tighten the $\frac{3}{8}$ " threaded rod or bolt 1 to $1\frac{1}{2}$ turns beyond snug tight.
5. Tighten the $\frac{1}{2}$ " threaded rod or bolt $\frac{1}{2}$ to 1 turn beyond snug tight.

NOTICE: Design defects that could cause injury or death may result from relying on the information in this document without independent verification by a qualified professional. The information in this document is provided "AS IS". Nucor Corporation and its affiliates expressly disclaim: (i) any and all representations, warranties and conditions and (ii) all liability arising out of or related to this document and the information in it.

The image shows a close-up, perspective view of several interlocking metal roof deck panels. The panels are a light grey color with a slightly textured surface. They are arranged in a row, overlapping each other. A solid green horizontal banner is superimposed over the middle of the panels, containing the text "ROOF DECK" in white, bold, uppercase letters.

ROOF DECK

2.0D DOVETAIL ROOF DECK GRADE 40 STEEL

LRFD

2.0D DOVETAIL ROOF DECK

- Enhanced 2-Coat Polyester Paint
- White Factory Primer Paint
- Galvanized Finish
- FM Listed

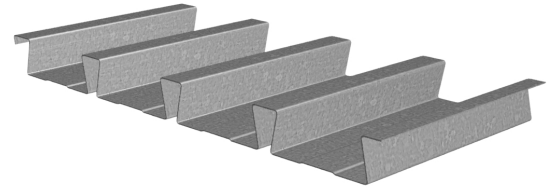

Nominal Dimensions

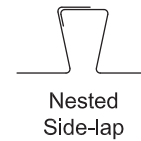
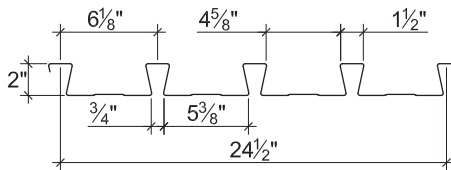

Section Properties

Deck Gage	Deck Weight w_{dd} (psf)	Base Metal Thickness t (in.)	Yield Strength F_y (ksi)	Effective Moment of Inertia at Service Load $I_d = (2I_e + I_o)/3$		Effective Section Modulus at $F_y = 40$ ksi		Design Moment		Vertical Web Shear ϕV_n (lb/ft)
				I_{d+} (in ⁴ /ft)	I_{d-} (in ⁴ /ft)	S_{e+} (in ³ /ft)	S_{e-} (in ³ /ft)	ϕM_{n+} (lb-ft/ft)	ϕM_{n-} (lb-ft/ft)	
22	2.1	0.0295	40	0.387	0.359	0.272	0.272	816	816	4401
20	2.6	0.0358	40	0.472	0.447	0.343	0.334	1029	1002	5316
18	3.4	0.0474	40	0.626	0.612	0.463	0.450	1389	1350	6968
16	4.3	0.0598	40	0.792	0.791	0.587	0.576	1761	1728	8698

Design Reactions at Supports Based on Web Crippling, ϕR_n (lb/ft)

Deck Gage	Bearing Length of Webs											
	One-Flange Loading						Two-Flange Loading					
	End Bearing				Interior Bearing		End Bearing				Interior Bearing	
	1 1/2"	2"	3"	4"	3"	5"	1 1/2"	2"	3"	4"	3"	5"
22	999	1098	1264	1403	1905	2255	1075	1158	1297	1415	2331	2792
20	1425	1561	1790	1982	2712	3192	1618	1737	1937	2105	3358	4001
18	2381	2596	2957	3262	4516	5272	2897	3094	3426	3705	5672	6705
16	3638	3951	4476	4919	6885	7973	4656	4953	5451	5871	8726	10235

Standard Features

- ASTM A653 SS GR 40 Min. with G90
- Standard lengths – 6'-0" to 42'-0"
- Tables conform to ANSI/SDI RD-2017
- IAPMO UES ER-423, FM and UL Listed

Optional Features

- Inquire regarding cost and lead times for:
 - 19 gage
 - Short cuts < 6'-0"
 - Alternative metallic and painted finishes
- Acoustical Version

2.0D DOVETAIL ROOF DECK GRADE 40 STEEL

Inward Uniform Design Loads, LRFD (psf)

Deck Gage	Spans	Criteria	Span (ft-in.)										
			4'-0"	5'-0"	6'-0"	7'-0"	8'-0"	9'-0"	10'-0"	11'-0"	12'-0"	13'-0"	14'-0"
22	Single	ϕW_n	408	261	181	133	102	81	65	54	45	39	33
		L/240	396	203	117	74	50	35	25	19	15	12	9
	Double	ϕW_n	398	257	179	132	101	80	65	54	45	39	33
		L/240	886	454	262	165	111	78	57	43	33	26	21
	Triple	ϕW_n	492	319	223	165	126	100	81	67	56	48	42
		L/240	694	355	206	130	87	61	44	33	26	20	16
20	Single	ϕW_n	514	329	229	168	129	102	82	68	57	49	42
		L/240	483	248	143	90	60	42	31	23	18	14	11
	Double	ϕW_n	488	315	220	162	124	98	80	66	55	47	41
		L/240	1103	565	327	206	138	97	71	53	41	32	26
	Triple	ϕW_n	602	391	273	202	155	123	100	82	69	59	51
		L/240	864	443	256	161	108	76	55	42	32	25	20
18	Single	ϕW_n	694	444	309	227	174	137	111	92	77	66	57
		L/240	641	328	190	120	80	56	41	31	24	19	15
	Double	ϕW_n	656	424	296	218	168	133	107	89	75	64	55
		L/240	1510	773	447	282	189	133	97	73	56	44	35
	Triple	ϕW_n	810	526	368	272	209	165	134	111	93	80	69
		L/240	1184	606	351	221	148	104	76	57	44	34	28
16	Single	ϕW_n	881	564	391	288	220	174	141	116	98	83	72
		L/240	811	415	240	151	101	71	52	39	30	24	19
	Double	ϕW_n	839	542	379	279	214	170	138	114	96	82	70
		L/240	1952	999	578	364	244	171	125	94	72	57	46
	Triple	ϕW_n	1035	672	471	348	267	211	172	142	119	102	88
		L/240	1530	783	453	285	191	134	98	74	57	45	36

Note:

1. Table does not account for web crippling. Required bearing should be determined based on specific span conditions.

NOTICE: Design defects that could cause injury or death may result from relying on the information in this document without independent verification by a qualified professional. The information in this document is provided "AS IS". Nucor Corporation and its affiliates expressly disclaim: (i) any and all representations, warranties and conditions and (ii) all liability arising out of or related to this document and the information in it.

3.5D DOVETAIL ROOF DECK GRADE 40 STEEL

LRFD

3.5D DOVETAIL ROOF DECK

- Enhanced 2-Coat Polyester Paint
- White Factory Primer Paint
- Galvanized Finish
- FM Listed

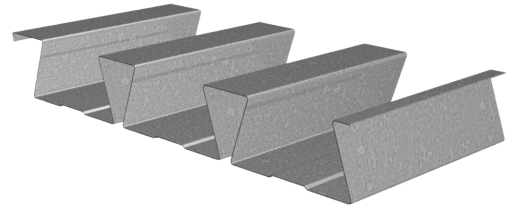

Nominal Dimensions

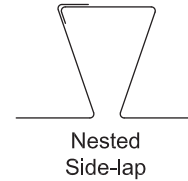
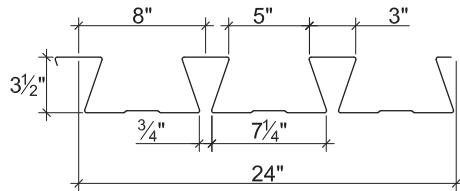

Section Properties

Deck Gage	Deck Weight w_{dd} (psf)	Base Metal Thickness t (in.)	Yield Strength F_y (ksi)	Effective Moment of Inertia at Service Load $I_d = (2I_e + I_g)/3$		Effective Section Modulus at $F_y = 40$ ksi		Design Moment		Vertical Web Shear ϕV_n (lb/ft)
				I_{d+} (in ⁴ /ft)	I_{d-} (in ⁴ /ft)	S_{e+} (in ³ /ft)	S_{e-} (in ³ /ft)	ϕM_{n+} (lb-ft/ft)	ϕM_{n-} (lb-ft/ft)	
20	3.3	0.0358	40	1.762	1.646	0.676	0.781	2028	2343	5221
18	4.3	0.0474	40	2.415	2.272	0.980	1.070	2940	3210	9138
16	5.4	0.0598	40	3.133	2.968	1.317	1.377	3951	4131	12635

Design Reactions at Supports Based on Web Crippling, ϕR_n (lb/ft)

Deck Gage	Bearing Length of Webs											
	One-Flange Loading						Two-Flange Loading					
	End Bearing				Interior Bearing		End Bearing				Interior Bearing	
	2"	3"	4"	5"	4"	6"	2"	3"	4"	5"	4"	6"
20	1060	1215	1346	1461	2170	2484	1092	1218	1324	1417	2564	2962
18	1787	2035	2245	2429	3602	4096	2004	2219	2399	2559	4354	4998
16	2744	3108	3416	3687	5475	6191	3270	3599	3876	4120	6717	7671

Standard Features

- ASTM A653 SS GR 40 Min. with G90
- Standard lengths – 6'-0" to 42'-0"
- Tables conform to ANSI/SDI RD-2017
- IAPMO UES ER-423, FM and UL Listed

Optional Features

- Inquire regarding cost and lead times for:
 - 19 gage
 - Short cuts < 6'-0"
 - Alternative metallic and painted finishes
- Acoustical Version

3.5D DOVETAIL ROOF DECK GRADE 40 STEEL

LRFD

Inward Uniform Design Loads, LRFD (psf)

Deck Gage	Spans	Criteria	Span (ft-in.)										
			11'-0"	12'-0"	13'-0"	14'-0"	15'-0"	16'-0"	17'-0"	18'-0"	19'-0"	20'-0"	21'-0"
20	Single	ϕW_n	134	113	96	83	72	63	56	50	45	41	37
		L/240	87	67	53	42	34	28	24	20	17	14	12
	Double	ϕW_n	152	128	109	94	82	73	64	57	52	47	42
		L/240	195	150	118	95	77	63	53	45	38	32	28
	Triple	ϕW_n	188	159	136	117							
		L/240	153	118	93	74							
18	Single	ϕW_n	194	163	139	120	105	92	81	73	65	59	53
		L/240	119	92	72	58	47	39	32	27	23	20	17
	Double	ϕW_n	210	176	151	130	113	100	88	79	71	64	58
		L/240	270	208	163	131	106	88	73	62	52	45	39
	Triple	ϕW_n	261	220	188	162							
		L/240	211	163	128	102							
16	Single	ϕW_n	261	220	187	161	140	123	109	98	88	79	72
		L/240	154	119	93	75	61	50	42	35	30	26	22
	Double	ϕW_n	270	227	194	167	146	128	114	102	91	82	75
		L/240	352	271	213	171	139	114	95	80	68	59	51
	Triple	ϕW_n	336	283	242	209							
		L/240	276	213	167	134							

Note:

1. Table does not account for web crippling. Required bearing should be determined based on specific span conditions.

NOTICE: Design defects that could cause injury or death may result from relying on the information in this document without independent verification by a qualified professional. The information in this document is provided "AS IS". Nucor Corporation and its affiliates expressly disclaim: (i) any and all representations, warranties and conditions and (ii) all liability arising out of or related to this document and the information in it.

1.5B-36/1.5BI-36/1.5PLB-36 ROOF DECKS

GRADE 50 STEEL

LRFD

1.5B ROOF DECKS

- 1.5B-36 Deck used with Side-lap Screws
- 1.5BI-36 Deck used with TSWs or BPs
- 1.5PLB-36 Deck used with PunchLok® II System

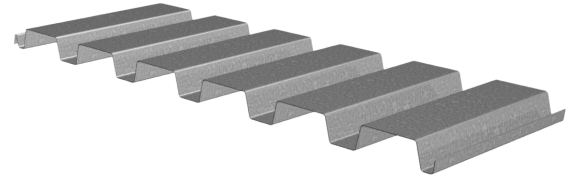

Nominal Dimensions

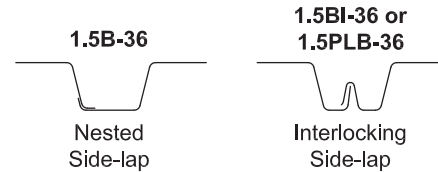
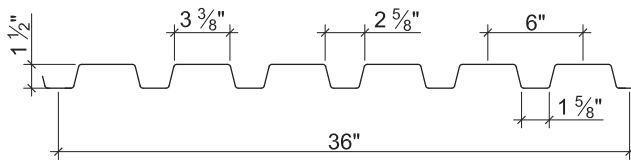

Section Properties

Deck Gage	Deck Weight w_{dd} (psf)	Base Metal Thickness t (in.)	Yield Strength F_y (ksi)	Effective Moment of Inertia at Service Load $I_d = (2I_e + I_g)/3$		Effective Section Modulus at $F_y = 50$ ksi		Design Moment		Vertical Web Shear ϕV_n (lb/ft)
				I_{d+} (in ⁴ /ft)	I_{d-} (in ⁴ /ft)	S_{e+} (in ³ /ft)	S_{e-} (in ³ /ft)	ϕM_{n+} (lb-ft/ft)	ϕM_{n-} (lb-ft/ft)	
22	1.6	0.0295	50	0.155	0.178	0.169	0.179	634	671	4035
20	2.0	0.0358	50	0.197	0.217	0.224	0.229	840	859	4874
19	2.3	0.0418	50	0.239	0.257	0.266	0.278	997	1042	5666
18	2.6	0.0474	50	0.277	0.290	0.306	0.318	1148	1193	6398
16	3.3	0.0598	50	0.364	0.367	0.393	0.402	1474	1508	7996

Design Reactions at Supports Based on Web Crippling, ϕR_n (lb/ft)

Deck Gage	Bearing Length of Webs											
	One-Flange Loading						Two-Flange Loading					
	End Bearing				Interior Bearing		End Bearing				Interior Bearing	
	1 1/2"	2"	3"	4"	3"	4"	1 1/2"	2"	3"	4"	3"	4"
22	1235	1357	1563	1706	2204	2383	1289	1389	1556	1672	2728	2966
20	1763	1932	2215	2408	3164	3406	1949	2093	2333	2497	3960	4286
19	2344	2562	2927	3169	4222	4527	2702	2893	3213	3426	5324	5740
18	2954	3221	3669	3959	5334	5699	3515	3754	4156	4417	6762	7265
16	4525	4915	5568	5967	8206	8709	5681	6043	6651	7023	10487	11191

Standard Features

- ASTM A653 SS GR50 Min., with G60 or G90, white or gray primer optional
- ASTM A1008 SS GR50 Min. with gray primer
- Standard lengths – 6'-0" to 42'-0"
- IAPMO UES ER-0652, UL, and FM Listed
- Tables conform to ANSI/SDI RD-2017

Optional Features

- Inquire regarding cost and lead times for:
 - Short cuts < 6'-0"
 - Sheet Lengths > 42'-0"
 - Alternative metallic and painted finishes
- Web Perforated Acoustical Versions

1.5B-36/1.5BI-36/1.5PLB-36 ROOF DECKS GRADE 50 STEEL

LRFD

Inward Uniform Design Loads, LRFD (psf)

Deck Gage	Spans	Criteria	Span (ft-in.)										
			2'-0"	3'-0"	4'-0"	5'-0"	6'-0"	7'-0"	8'-0"	9'-0"	10'-0"	11'-0"	12'-0"
22	Single	ϕW_n	1267	563	317	203	141	103	79	63	51	42	35
		L/240	1270	376	159	81	47	30	20	14	10	8	6
	Double	ϕW_n	1240	575	329	212	148	109	83	66	54	44	37
		L/240	3514	1041	439	225	130	82	55	39	28	21	16
	Triple	ϕW_n	1502	708	407	263	184	136	104	82	67	55	46
		L/240	2754	816	344	176	102	64	43	30	22	17	13
20	Single	ϕW_n	1679	746	420	269	187	137	105	83	67	56	47
		L/240	1614	478	202	103	60	38	25	18	13	10	7
	Double	ϕW_n	1572	732	419	271	189	139	107	84	68	57	48
		L/240	4283	1269	535	274	159	100	67	47	34	26	20
	Triple	ϕW_n	1898	900	519	336	235	173	133	105	85	71	59
		L/240	3357	995	420	215	124	78	52	37	27	20	16
19	Single	ϕW_n	1994	886	499	319	222	163	125	98	80	66	55
		L/240	1958	580	245	125	73	46	31	21	16	12	9
	Double	ϕW_n	1894	886	508	328	229	169	129	102	83	69	58
		L/240	5073	1503	634	325	188	118	79	56	41	30	23
	Triple	ϕW_n	2281	1087	628	407	285	210	161	128	104	86	72
		L/240	3976	1178	497	254	147	93	62	44	32	24	18
18	Single	ϕW_n	2295	1020	574	367	255	187	143	113	92	76	64
		L/240	2270	673	284	145	84	53	35	25	18	14	11
	Double	ϕW_n	2162	1012	581	375	262	193	148	117	95	79	66
		L/240	5724	1696	716	366	212	134	89	63	46	34	27
	Triple	ϕW_n	2602	1242	718	465	326	240	185	146	119	98	82
		L/240	4487	1329	561	287	166	105	70	49	36	27	21
16	Single	ϕW_n	2948	1310	737	472	328	241	184	146	118	97	82
		L/240	2983	884	373	191	110	70	47	33	24	18	14
	Double	ϕW_n	2727	1278	734	474	331	244	187	148	120	99	83
		L/240	7244	2146	906	464	268	169	113	79	58	44	34
	Triple	ϕW_n	3280	1567	907	588	412	304	233	185	150	124	104
		L/240	5678	1682	710	363	210	132	89	62	45	34	26

Note:

1. Table does not account for web crippling. Required bearing should be determined based on specific span conditions.

NOTICE: Design defects that could cause injury or death may result from relying on the information in this document without independent verification by a qualified professional. The information in this document is provided "AS IS". Nucor Corporation and its affiliates expressly disclaim: (i) any and all representations, warranties and conditions and (ii) all liability arising out of or related to this document and the information in it.

1.5B-36/1.5BI-36/1.5PLB-36 ROOF DECKS

GRADE 80 STEEL

LRFD

1.5B ROOF DECKS

- 1.5B-36 Deck used with Side-lap Screws
- 1.5BI-36 Deck used with TSWs or BPs
- 1.5PLB-36 Deck used with PunchLok® II System

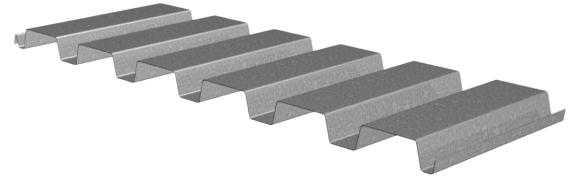

Nominal Dimensions

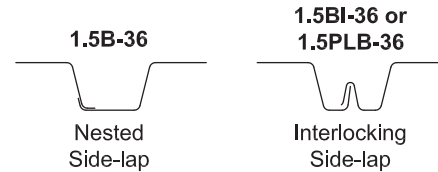
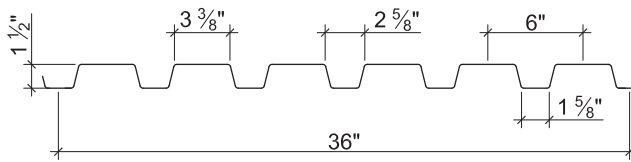

Section Properties

Deck Gage	Deck Weight w_{dd} (psf)	Base Metal Thickness t (in.)	Yield Strength F_y (ksi)	Effective Moment of Inertia at Service Load $I_d = (2I_e + I_g)/3$		Effective Section Modulus at $F_y = 60$ ksi		Design Moment		Vertical Web Shear ϕV_n (lb/ft)
				I_{d+} (in ⁴ /ft)	I_{d-} (in ⁴ /ft)	S_{e+} (in ³ /ft)	S_{e-} (in ³ /ft)	ϕM_{n+} (lb-ft/ft)	ϕM_{n-} (lb-ft/ft)	
24	1.3	0.0239	60	0.118	0.138	0.120	0.131	540	590	2357
22	1.6	0.0295	60	0.151	0.175	0.162	0.173	729	779	4842
20	2.0	0.0358	60	0.192	0.217	0.215	0.223	968	1004	5849
19	2.3	0.0418	60	0.232	0.254	0.263	0.271	1184	1220	6799
18	2.6	0.0474	60	0.272	0.290	0.302	0.315	1359	1418	7678

Design Reactions at Supports Based on Web Crippling, ϕR_n (lb/ft)

Deck Gage	Bearing Length of Webs											
	One-Flange Loading						Two-Flange Loading					
	End Bearing				Interior Bearing		End Bearing				Interior Bearing	
	1 1/2"	2"	3"	4"	3"	4"	1 1/2"	2"	3"	4"	3"	4"
24	1005	1108	1281	1405	1781	1933	977	1057	1190	1285	2171	2371
22	1482	1629	1875	2047	2645	2859	1547	1666	1867	2007	3273	3559
20	2116	2318	2658	2889	3797	4087	2339	2511	2800	2997	4752	5143
19	2813	3074	3512	3803	5067	5432	3243	3472	3856	4111	6389	6888
18	3545	3865	4403	4751	6401	6839	4218	4505	4987	5300	8114	8718

Standard Features

- ASTM A653 SS GR80, with G60 or G90, white or gray primer optional
- ASTM A1008 SS GR80 with gray primer
- Standard lengths – 6'-0" to 42'-0"
- IAPMO UES ER-0652, UL, and FM Listed
- Tables conform to ANSI/SDI RD-2017

Optional Features

- Inquire regarding cost and lead times for:
 - Short cuts < 6'-0"
 - Sheet Lengths > 42'-0"
 - Alternative metallic and painted finishes
- Web Perforated Acoustical Versions

1.5B-36/1.5BI-36/1.5PLB-36 ROOF DECKS

GRADE 80 STEEL

LRFD

Inward Uniform Design Loads, LRFD (psf)

Deck Gage	Spans	Criteria	Span (ft-in.)										
			2'-0"	3'-0"	4'-0"	5'-0"	6'-0"	7'-0"	8'-0"	9'-0"	10'-0"	11'-0"	12'-0"
24	Single	ϕW_n	1080	480	270	173	120	88	68	53	43	36	30
		L/240	967	287	121	62	36	23	15	11	8	6	4
	Double	ϕW_n	1000	484	281	183	128	95	73	58	47	39	33
		L/240	2724	807	341	174	101	64	43	30	22	16	13
	Triple	ϕW_n	1179	586	345	226	159	118	91	72	58	48	41
		L/240	2135	633	267	137	79	50	33	23	17	13	10
22	Single	ϕW_n	1458	648	365	233	162	119	91	72	58	48	41
		L/240	1237	367	155	79	46	29	19	14	10	7	6
	Double	ϕW_n	1445	668	382	246	171	126	97	77	62	51	43
		L/240	3454	1024	432	221	128	81	54	38	28	21	16
	Triple	ϕW_n	1753	823	473	306	214	157	121	96	77	64	54
		L/240	2707	802	338	173	100	63	42	30	22	16	13
20	Single	ϕW_n	1935	860	484	310	215	158	121	96	77	64	54
		L/240	1573	466	197	101	58	37	25	17	13	9	7
	Double	ϕW_n	1844	858	491	316	221	163	125	99	80	66	56
		L/240	4283	1269	535	274	159	100	67	47	34	26	20
	Triple	ϕW_n	2231	1055	607	393	275	203	156	123	100	83	69
		L/240	3357	995	420	215	124	78	52	37	27	20	16
19	Single	ϕW_n	2367	1052	592	379	263	193	148	117	95	78	66
		L/240	1901	563	238	122	70	44	30	21	15	11	9
	Double	ϕW_n	2226	1039	595	384	268	197	151	120	97	80	68
		L/240	5014	1486	627	321	186	117	78	55	40	30	23
	Triple	ϕW_n	2685	1275	736	477	333	246	189	149	121	100	84
		L/240	3930	1164	491	252	146	92	61	43	31	24	18
18	Single	ϕW_n	2718	1208	680	435	302	222	170	134	109	90	76
		L/240	2229	660	279	143	83	52	35	24	18	13	10
	Double	ϕW_n	2574	1204	691	446	311	229	176	139	113	93	79
		L/240	5724	1696	716	366	212	134	89	63	46	34	27
	Triple	ϕW_n	3100	1477	854	554	387	286	219	174	141	117	98
		L/240	4487	1329	561	287	166	105	70	49	36	27	21

Note:

1. Table does not account for web crippling. Required bearing should be determined based on specific span conditions.

NOTICE: Design defects that could cause injury or death may result from relying on the information in this document without independent verification by a qualified professional. The information in this document is provided "AS IS". Nucor Corporation and its affiliates expressly disclaim: (i) any and all representations, warranties and conditions and (ii) all liability arising out of or related to this document and the information in it.

3NL-32/3NI-32/3PLN-32 ROOF DECKS

GRADE 50 STEEL

LRFD

32" WIDE 3N ROOF DECKS

- 3NL-32 Deck used with Side-lap Screws
- 3NI-32 Deck used with TSWs or BPs
- 3PLN-32 Deck used with PunchLok® II System

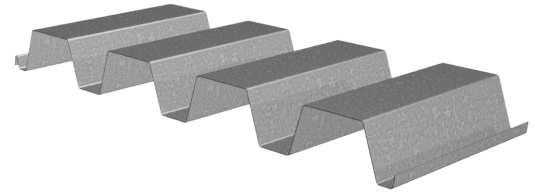

Nominal Dimensions

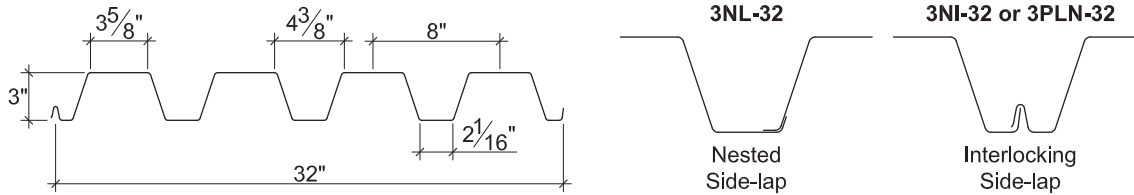

Section Properties

Deck Gage	Deck Weight w_{dd} (psf)	Base Metal Thickness t (in.)	Yield Strength F_y (ksi)	Effective Moment of Inertia at Service Load $I_d = (2I_e + I_g)/3$		Effective Section Modulus at $F_y = 50$ ksi		Design Moment		Vertical Web Shear ϕV_n (lb/ft)
				I_{d+} (in ⁴ /ft)	I_{d-} (in ⁴ /ft)	S_{e+} (in ³ /ft)	S_{e-} (in ³ /ft)	ϕM_{n+} (lb-ft/ft)	ϕM_{n-} (lb-ft/ft)	
22	1.8	0.0295	50	0.643	0.715	0.345	0.372	1294	1395	3307
20	2.2	0.0358	50	0.806	0.886	0.448	0.476	1680	1785	5716
19	2.6	0.0418	50	0.965	1.052	0.554	0.579	2077	2172	7793
18	2.9	0.0474	50	1.123	1.200	0.660	0.675	2475	2532	10028
16	3.7	0.0598	50	1.479	1.524	0.869	0.885	3259	3319	13777

Design Reactions at Supports Based on Web Crippling, ϕR_n (lb/ft)

Deck Gage	Bearing Length of Webs											
	One-Flange Loading						Two-Flange Loading					
	End Bearing				Interior Bearing		End Bearing				Interior Bearing	
	1 1/2"	2"	3"	4"	4"	8"	1 1/2"	2"	3"	4"	4"	8"
22	820	901	1037	1152	1763	2049	777	837	938	1023	2053	2410
20	1184	1297	1487	1647	2524	3126	1206	1295	1444	1569	2996	3762
19	1586	1733	1979	2187	3358	4227	1701	1821	2022	2192	4038	5163
18	2009	2191	2496	2752	4234	5304	2239	2392	2648	2864	5138	6540
16	3108	3375	3823	4201	6493	8057	3693	3928	4323	4656	7994	10087

Standard Features

- ASTM A653 SS GR50 Min., with G60 or G90, white or gray primer optional
- ASTM A1008 SS GR50 Min. with gray primer
- Standard lengths – 6'-0" to 42'-0"
- IAPMO UES ER-0652, UL, and FM Listed
- Tables conform to ANSI/SDI RD-2017

Optional Features

- Inquire regarding cost and lead times for:
 - Short cuts < 6'-0"
 - Sheet Lengths > 42'-0"
 - Alternative metallic and painted finishes
- Web Perforated Acoustical Versions

3NL-32/3NI-32/3PLN-32 ROOF DECKS GRADE 50 STEEL

LRFD

Inward Uniform Design Loads, LRFD (psf)

Deck Gage	Spans	Criteria	Span (ft-in.)										
			4'-0"	6'-0"	8'-0"	9'-0"	10'-0"	11'-0"	12'-0"	14'-0"	16'-0"	18'-0"	20'-0"
22	Single	ϕW_n	647	288	162	128	104	86	72	53	40	32	26
		L/240	659	195	82	58	42	32	24	15	10	7	5
	Double	ϕW_n	617	292	169	134	109	91	76	56	43	34	28
		L/240	1764	523	221	155	113	85	65	41	28	19	14
	Triple	ϕW_n	737	357	208	166	135	112	95	70			
		L/240	1383	410	173	121	88	66	51	32			
20	Single	ϕW_n	840	373	210	166	134	111	93	69	53	41	34
		L/240	826	245	103	72	53	40	31	19	13	9	7
	Double	ϕW_n	831	384	219	174	141	117	98	72	56	44	36
		L/240	2186	648	273	192	140	105	81	51	34	24	17
	Triple	ϕW_n	1010	473	272	216	175	145	122	90			
		L/240	1713	508	214	150	110	82	63	40			
19	Single	ϕW_n	1039	462	260	205	166	137	115	85	65	51	42
		L/240	988	293	124	87	63	48	37	23	15	11	8
	Double	ϕW_n	1025	470	267	212	172	142	120	88	68	53	43
		L/240	2596	769	324	228	166	125	96	61	41	28	21
	Triple	ϕW_n	1252	581	332	264	214	177	149	110			
		L/240	2034	603	254	179	130	98	75	47			
18	Single	ϕW_n	1238	550	309	244	198	164	138	101	77	61	50
		L/240	1150	341	144	101	74	55	43	27	18	13	9
	Double	ϕW_n	1207	551	313	248	201	166	140	103	79	62	51
		L/240	2961	877	370	260	189	142	110	69	46	32	24
	Triple	ϕW_n	1480	682	389	308	250	207	174	128			
		L/240	2321	688	290	204	149	112	86	54			
16	Single	ϕW_n	1629	724	407	322	261	215	181	133	102	80	65
		L/240	1515	449	189	133	97	73	56	35	24	17	12
	Double	ϕW_n	1589	723	410	325	264	218	183	135	103	82	66
		L/240	3760	1114	470	330	241	181	139	88	59	41	30
	Triple	ϕW_n	1951	896	510	405	329	272	229	168			
		L/240	2947	873	368	259	189	142	109	69			

Note:

1. Table does not account for web crippling. Required bearing should be determined based on specific span conditions.

NOTICE: Design defects that could cause injury or death may result from relying on the information in this document without independent verification by a qualified professional. The information in this document is provided "AS IS". Nucor Corporation and its affiliates expressly disclaim: (i) any and all representations, warranties and conditions and (ii) all liability arising out of or related to this document and the information in it.

3NL-32/3NI-32/3PLN-32 ROOF DECKS

GRADE 80 STEEL

LRFD

32" WIDE 3N ROOF DECKS

- 3NL-32 Deck used with Side-lap Screws
- 3NI-32 Deck used with TSWs or BPs
- 3PLN-32 Deck used with PunchLok® II System

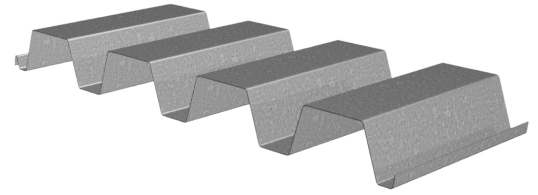

Nominal Dimensions

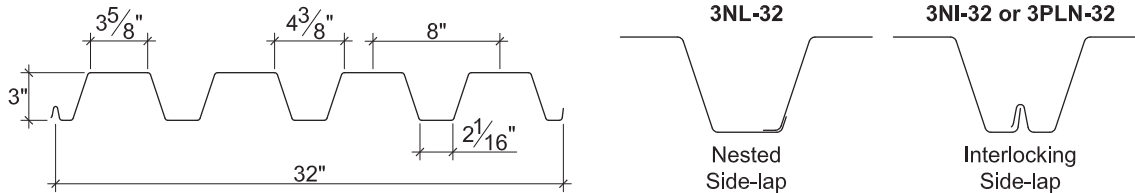

Section Properties

Deck Gage	Deck Weight w_{dd} (psf)	Base Metal Thickness t (in.)	Yield Strength F_y (ksi)	Effective Moment of Inertia at Service Load $I_d = (2I_e + I_g)/3$		Effective Section Modulus at $F_y = 60$ ksi		Design Moment		Vertical Web Shear ϕV_n (lb/ft)
				I_{d+} (in ⁴ /ft)	I_{d-} (in ⁴ /ft)	S_{e+} (in ³ /ft)	S_{e-} (in ³ /ft)	ϕM_{n+} (lb-ft/ft)	ϕM_{n-} (lb-ft/ft)	
22	1.8	0.0295	60	0.635	0.707	0.335	0.346	1508	1557	3307
20	2.2	0.0358	60	0.794	0.876	0.434	0.463	1953	2084	5926
19	2.6	0.0418	60	0.950	1.040	0.536	0.563	2412	2534	8537
18	2.9	0.0474	60	1.103	1.195	0.637	0.659	2867	2966	10985

Design Reactions at Supports Based on Web Crippling, ϕR_n (lb/ft)

Deck Gage	Bearing Length of Webs											
	One-Flange Loading						Two-Flange Loading					
	End Bearing				Interior Bearing		End Bearing				Interior Bearing	
	1 1/2"	2"	3"	4"	4"	8"	1 1/2"	2"	3"	4"	4"	8"
22	984	1081	1245	1383	2115	2459	933	1005	1126	1227	2464	2891
20	1421	1557	1785	1977	3029	3751	1448	1554	1733	1883	3595	4515
19	1903	2079	2375	2625	4030	5073	2041	2185	2427	2630	4845	6195
18	2411	2629	2995	3303	5081	6364	2687	2870	3178	3437	6166	7848

Standard Features

- ASTM A653 SS GR80, with G60 or G90, white or gray primer optional
- ASTM A1008 SS GR50 with gray primer
- Standard lengths – 6'-0" to 42'-0"
- IAPMO UES ER-0652, UL, and FM Listed
- Tables conform to ANSI/SDI RD-2017

Optional Features

- Inquire regarding cost and lead times for:
 - Short cuts < 6'-0"
 - Sheet Lengths > 42'-0"
 - Alternative metallic and painted finishes
- Web Perforated Acoustical Versions

3NL-32/3NI-32/3PLN-32 ROOF DECKS

GRADE 80 STEEL

LRFD

Inward Uniform Design Loads, LRFD (psf)

Deck Gage	Spans	Criteria	Span (ft-in.)										
			4'-0"	6'-0"	8'-0"	9'-0"	10'-0"	11'-0"	12'-0"	14'-0"	16'-0"	18'-0"	20'-0"
22	Single	ϕW_n	754	335	188	149	121	100	84	62	47	37	30
		L/240	650	193	81	57	42	31	24	15	10	7	5
	Double	ϕW_n	671	322	187	149	121	101	85	63	48	38	31
		L/240	1744	517	218	153	112	84	65	41	27	19	14
	Triple	ϕW_n	795	391	229	183	150	125	105	78			
		L/240	1367	405	171	120	88	66	51	32			
20	Single	ϕW_n	977	434	244	193	156	129	109	80	61	48	39
		L/240	813	241	102	71	52	39	30	19	13	9	7
	Double	ϕW_n	954	444	254	202	164	136	115	84	65	51	42
		L/240	2161	640	270	190	138	104	80	50	34	24	17
	Triple	ϕW_n	1152	546	315	250	204	169	143	105			
		L/240	1694	502	212	149	108	81	63	40			
19	Single	ϕW_n	1206	536	302	238	193	159	134	98	75	60	48
		L/240	973	288	122	85	62	47	36	23	15	11	8
	Double	ϕW_n	1188	547	311	247	200	166	140	103	79	62	51
		L/240	2566	760	321	225	164	123	95	60	40	28	21
	Triple	ϕW_n	1447	675	386	307	249	207	174	128			
		L/240	2011	596	251	177	129	97	74	47			
18	Single	ϕW_n	1433	637	358	283	229	190	159	117	90	71	57
		L/240	1130	335	141	99	72	54	42	26	18	12	9
	Double	ϕW_n	1405	643	366	290	235	195	164	120	92	73	59
		L/240	2949	874	369	259	189	142	109	69	46	32	24
	Triple	ϕW_n	1718	795	454	360	293	242	204	150			
		L/240	2311	685	289	203	148	111	86	54			

Note:

1. Table does not account for web crippling. Required bearing should be determined based on specific span conditions.

NOTICE: Design defects that could cause injury or death may result from relying on the information in this document without independent verification by a qualified professional. The information in this document is provided "AS IS". Nucor Corporation and its affiliates expressly disclaim: (i) any and all representations, warranties and conditions and (ii) all liability arising out of or related to this document and the information in it.

3N-24/3NI-24 ROOF DECKS GRADE 40 STEEL

LRFD

24" WIDE 3N ROOF DECKS

- 3N-24 Deck used with Side-lap Screws
- 3NI-24 Deck used with TSWs or BPs

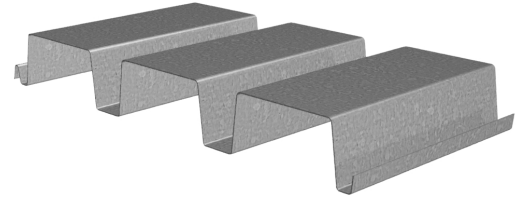

Nominal Dimensions

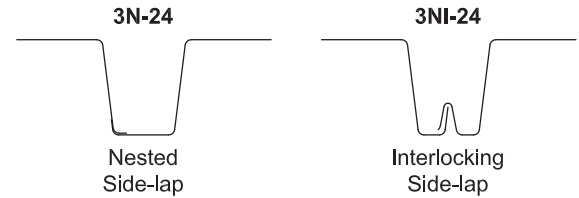
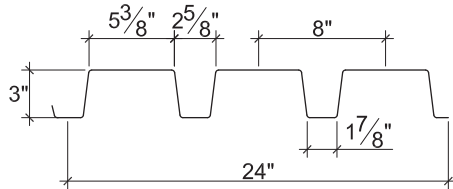

Section Properties

Deck Gage	Deck Weight w_{dd} (psf)	Base Metal Thickness t (in.)	Yield Strength F_y (ksi)	Effective Moment of Inertia at Service Load $I_d = (2I_e + I_g)/3$		Effective Section Modulus at $F_y = 40$ ksi		Design Moment		Vertical Web Shear ϕV_n (lb/ft)
				I_{d+} (in ⁴ /ft)	I_{d-} (in ⁴ /ft)	S_{e+} (in ³ /ft)	S_{e-} (in ³ /ft)	ϕM_{n+} (lb-ft/ft)	ϕM_{n-} (lb-ft/ft)	
22	2.0	0.0295	40	0.714	0.869	0.368	0.419	1104	1257	3703
20	2.5	0.0358	40	0.901	1.071	0.482	0.530	1446	1590	5455
19	2.9	0.0418	40	1.088	1.252	0.584	0.637	1752	1911	7439
18	3.3	0.0474	40	1.268	1.421	0.674	0.731	2022	2193	8721
16	4.1	0.0598	40	1.682	1.795	0.876	0.934	2628	2802	10951

Design Reactions at Supports Based on Web Crippling, ϕR_n (lb/ft)

Deck Gage	Bearing Length of Webs											
	One-Flange Loading						Two-Flange Loading					
	End Bearing				Interior Bearing		End Bearing				Interior Bearing	
	1 1/2"	2"	3"	4"	4"	8"	1 1/2"	2"	3"	4"	4"	8"
22	708	778	896	995	1508	1753	679	731	819	893	1769	2076
20	1021	1119	1282	1420	2158	2672	1050	1127	1257	1366	2577	3236
19	1366	1493	1706	1885	2872	3614	1477	1582	1757	1904	3472	4439
18	1729	1886	2148	2369	3619	4532	1942	2074	2296	2483	4414	5618
16	2670	2899	3284	3609	5543	6878	3191	3395	3736	4024	6856	8651

Standard Features

- ASTM A653 SS GR40 Min., with G60 or G90, white or gray primer optional
- ASTM A1008 SS GR40 Min. with gray primer
- Standard lengths – 6'-0" to 42'-0"
- IAPMO UES ER-0652, UL, and FM Listed
- Tables conform to ANSI/SDI RD-2017

Optional Features

- Inquire regarding cost and lead times for:
 - Short cuts < 6'-0"
 - Sheet Lengths > 42'-0"
 - Alternative metallic and painted finishes
- Web Perforated Acoustical Versions

3N-24/3NI-24 ROOF DECKS GRADE 40 STEEL

LRFD

Inward Uniform Design Loads, LRFD (psf)

Deck Gage	Spans	Criteria	Span (ft-in.)										
			4'-0"	6'-0"	8'-0"	9'-0"	10'-0"	11'-0"	12'-0"	14'-0"	16'-0"	18'-0"	20'-0"
22	Single	ϕW_n	552	245	138	109	88	73	61	45	35	27	22
		L/240	731	217	91	64	47	35	27	17	11	8	6
	Double	ϕW_n	579	269	154	122	99	82	69	51	39	31	25
		L/240	2144	635	268	188	137	103	79	50	34	24	17
	Triple	ϕW_n	700	331	190	151	123	102	86	63			
		L/240	1681	498	210	148	108	81	62	39			
20	Single	ϕW_n	723	321	181	143	116	96	80	59	45	36	29
		L/240	923	273	115	81	59	44	34	22	14	10	7
	Double	ϕW_n	747	343	196	155	126	104	88	65	49	39	32
		L/240	2643	783	330	232	169	127	98	62	41	29	21
	Triple	ϕW_n	911	424	243	193	157	130	109	81			
		L/240	2071	614	259	182	133	100	77	48			
19	Single	ϕW_n	876	389	219	173	140	116	97	72	55	43	35
		L/240	1114	330	139	98	71	54	41	26	17	12	9
	Double	ϕW_n	910	415	236	187	152	125	106	78	60	47	38
		L/240	3089	915	386	271	198	149	114	72	48	34	25
	Triple	ϕW_n	1114	514	293	233	189	156	132	97			
		L/240	2421	717	303	213	155	116	90	56			
18	Single	ϕW_n	1011	449	253	200	162	134	112	83	63	50	40
		L/240	1299	385	162	114	83	62	48	30	20	14	10
	Double	ϕW_n	1046	477	271	215	174	144	121	89	68	54	44
		L/240	3506	1039	438	308	224	169	130	82	55	38	28
	Triple	ϕW_n	1283	591	337	267	217	180	151	111			
		L/240	2748	814	344	241	176	132	102	64			
16	Single	ϕW_n	1314	584	329	260	210	174	146	107	82	65	53
		L/240	1723	510	215	151	110	83	64	40	27	19	14
	Double	ϕW_n	1334	609	346	274	222	184	155	114	87	69	56
		L/240	4429	1312	554	389	283	213	164	103	69	49	35
	Triple	ϕW_n	1635	754	430	341	277	229	193	142			
		L/240	3471	1029	434	305	222	167	129	81			

Note:

1. Table does not account for web crippling. Required bearing should be determined based on specific span conditions.

NOTICE: Design defects that could cause injury or death may result from relying on the information in this document without independent verification by a qualified professional. The information in this document is provided "AS IS". Nucor Corporation and its affiliates expressly disclaim: (i) any and all representations, warranties and conditions and (ii) all liability arising out of or related to this document and the information in it.

2.0DA ACOUSTICAL DOVETAIL ROOF DECK GRADE 40 STEEL

LRFD

2.0DA ACOUSTICAL DOVETAIL ROOF DECK

- Enhanced 2-Coat Polyester Paint
- White Factory Primer Paint
- Galvanized Finish
- FM Listed

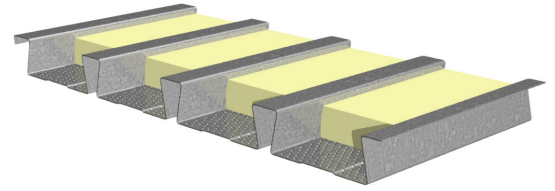

Nominal Dimensions

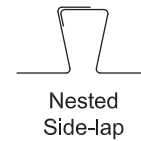
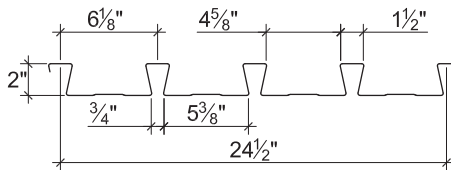

Section Properties

Deck Gage	Deck Weight w_{dd} (psf)	Base Metal Thickness t (in.)	Yield Strength F_y (ksi)	Effective Moment of Inertia at Service Load $I_d = (2I_e + I_p)/3$		Effective Section Modulus at $F_y = 40$ ksi		Design Moment		Vertical Web Shear ϕV_n (lb/ft)
				I_{d+} (in ⁴ /ft)	I_{d-} (in ⁴ /ft)	S_{e+} (in ³ /ft)	S_{e-} (in ³ /ft)	ϕM_{n+} (lb-ft/ft)	ϕM_{n-} (lb-ft/ft)	
22	2.0	0.0295	40	0.340	0.310	0.261	0.258	783	774	4401
20	2.4	0.0358	40	0.415	0.385	0.330	0.317	990	951	5316
18	3.2	0.0474	40	0.551	0.528	0.445	0.427	1335	1281	6968
16	4.0	0.0598	40	0.697	0.684	0.564	0.546	1692	1638	8698

Design Reactions at Supports Based on Web Crippling, ϕR_n (lb/ft)

Deck Gage	Bearing Length of Webs											
	One-Flange Loading						Two-Flange Loading					
	End Bearing				Interior Bearing		End Bearing				Interior Bearing	
	1 1/2"	2"	3"	4"	3"	5"	1 1/2"	2"	3"	4"	3"	5"
22	999	1098	1264	1403	1905	2255	1075	1158	1297	1415	2331	2792
20	1425	1561	1790	1982	2712	3192	1618	1737	1937	2105	3358	4001
18	2381	2596	2957	3262	4516	5272	2897	3094	3426	3705	5672	6705
16	3638	3951	4476	4919	6885	7973	4656	4953	5451	5871	8726	10235

Standard Features

- ASTM A653 SS GR 40 Min. with G90
- Standard lengths – 6'-0" to 42'-0"
- Tables conform to ANSI/SDI RD-2017
- IAPMO UES ER-423 and FM Listed

Optional Features

- Inquire regarding cost and lead times for:
 - 19 gage
 - Short cuts < 6'-0"
 - Alternative metallic and painted finishes

2.0DA ACOUSTICAL DOVETAIL ROOF DECK GRADE 40 STEEL

LRFD

Inward Uniform Design Loads, LRFD (psf)

Deck Gage	Spans	Criteria	Span (ft-in.)										
			4'-0"	5'-0"	6'-0"	7'-0"	8'-0"	9'-0"	10'-0"	11'-0"	12'-0"	13'-0"	14'-0"
22	Single	ϕW_n	392	251	174	128	98	77	63	52	44	37	32
		L/240	348	178	103	65	44	31	22	17	13	10	8
	Double	ϕW_n	378	244	170	125	96	76	62	51	43	37	32
		L/240	765	392	227	143	96	67	49	37	28	22	18
	Triple	ϕW_n	468	303	212	156	120	95	77	64	54	46	39
		L/240	600	307	178	112	75	53	38	29	22	17	14
20	Single	ϕW_n	495	317	220	162	124	98	79	65	55	47	40
		L/240	425	218	126	79	53	37	27	20	16	12	10
	Double	ϕW_n	464	300	209	154	118	93	76	63	53	45	39
		L/240	950	486	281	177	119	83	61	46	35	28	22
	Triple	ϕW_n	574	372	260	192	147	117	95	78	66	56	48
		L/240	745	381	221	139	93	65	48	36	28	22	17
18	Single	ϕW_n	667	427	297	218	167	132	107	88	74	63	54
		L/240	564	289	167	105	71	50	36	27	21	16	13
	Double	ϕW_n	624	403	281	207	159	126	102	84	71	60	52
		L/240	1303	667	386	243	163	114	83	63	48	38	30
	Triple	ϕW_n	772	500	350	258	198	157	127	105	89	76	65
		L/240	1021	523	303	191	128	90	65	49	38	30	24
16	Single	ϕW_n	846	541	376	276	212	167	135	112	94	80	69
		L/240	714	366	212	133	89	63	46	34	26	21	17
	Double	ϕW_n	797	515	360	265	203	161	130	108	91	77	67
		L/240	1688	864	500	315	211	148	108	81	63	49	39
	Triple	ϕW_n	985	639	447	330	253	201	163	135	113	97	83
		L/240	1323	677	392	247	165	116	85	64	49	39	31

Note:

1. Table does not account for web crippling. Required bearing should be determined based on specific span conditions.

NOTICE: Design defects that could cause injury or death may result from relying on the information in this document without independent verification by a qualified professional. The information in this document is provided "AS IS". Nucor Corporation and its affiliates expressly disclaim: (i) any and all representations, warranties and conditions and (ii) all liability arising out of or related to this document and the information in it.

3.5DA ACOUSTICAL DOVETAIL ROOF DECK GRADE 40 STEEL

LRFD

3.5DA ACOUSTICAL DOVETAIL ROOF DECK

- Enhanced 2-Coat Polyester Paint
- White Factory Primer Paint
- Galvanized Finish
- FM Listed

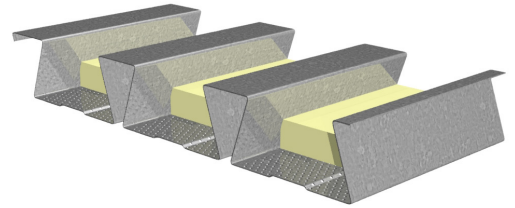

Nominal Dimensions

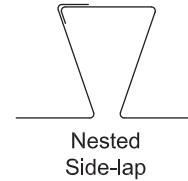
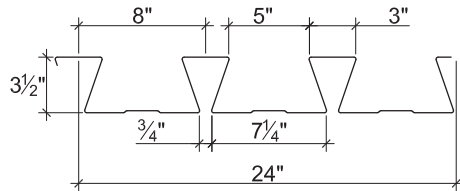

Section Properties

Deck Gage	Deck Weight w_{dd} (psf)	Base Metal Thickness t (in.)	Yield Strength F_y (ksi)	Effective Moment of Inertia at Service Load $I_d = (2I_e + I_g)/3$		Effective Section Modulus at $F_y = 40$ ksi		Design Moment		Vertical Web Shear ϕV_n (lb/ft)
				I_{d+} (in ⁴ /ft)	I_{d-} (in ⁴ /ft)	S_{e+} (in ³ /ft)	S_{e-} (in ³ /ft)	ϕM_{n+} (lb-ft/ft)	ϕM_{n-} (lb-ft/ft)	
20	3.1	0.0358	40	1.531	1.430	0.655	0.657	1965	1971	5221
18	4.1	0.0474	40	2.098	1.950	0.934	0.928	2802	2784	9138
16	5.1	0.0598	40	2.719	2.533	1.255	1.241	3765	3723	12635

Design Reactions at Supports Based on Web Crippling, ϕR_n (lb/ft)

Deck Gage	Bearing Length of Webs											
	One-Flange Loading						Two-Flange Loading					
	End Bearing				Interior Bearing		End Bearing				Interior Bearing	
	2"	3"	4"	5"	4"	6"	2"	3"	4"	5"	4"	6"
20	1060	1215	1346	1461	2170	2484	1092	1218	1324	1417	2564	2962
18	1787	2035	2245	2429	3602	4096	2004	2219	2399	2559	4354	4998
16	2744	3108	3416	3687	5475	6191	3270	3599	3876	4120	6717	7671

Standard Features

- ASTM A653 SS GR 40 Min. with G90
- Standard lengths – 6'-0" to 42'-0"
- Tables conform to ANSI/SDI RD-2017
- IAPMO UES ER-423 and FM Listed

Optional Features

- Inquire regarding cost and lead times for:
 - 19 gage
 - Short cuts < 6'-0"
 - Alternative metallic and painted finishes

3.5DA ACOUSTICAL DOVETAIL ROOF DECK GRADE 40 STEEL

LRFD

Inward Uniform Design Loads, LRFD (psf)

Deck Gage	Spans	Criteria	Span (ft-in.)										
			11'-0"	12'-0"	13'-0"	14'-0"	15'-0"	16'-0"	17'-0"	18'-0"	19'-0"	20'-0"	21'-0"
20	Single	ϕW_n	130	109	93	80	70	61	54	49	44	39	36
		L/240	75	58	46	37	30	25	20	17	15	13	11
	Double	ϕW_n	128	108	92	80	70	61	54	48	43	39	36
		L/240	170	131	103	82	67	55	46	39	33	28	24
	Triple	ϕW_n	160	135	115	99							
		L/240	133	102	81	65							
18	Single	ϕW_n	185	156	133	114	100	88	78	69	62	56	51
		L/240	103	80	63	50	41	34	28	24	20	17	15
	Double	ϕW_n	182	153	131	113	98	87	77	68	61	56	50
		L/240	231	178	140	112	91	75	63	53	45	38	33
	Triple	ϕW_n	227	191	163	141							
		L/240	181	140	110	88							
16	Single	ϕW_n	249	209	178	154	134	118	104	93	83	75	68
		L/240	134	103	81	65	53	44	36	31	26	22	19
	Double	ϕW_n	244	205	175	151	132	116	103	92	82	74	67
		L/240	301	231	182	146	119	98	81	69	58	50	43
	Triple	ϕW_n	304	256	218	188							
		L/240	236	181	143	114							

Note:

1. Table does not account for web crippling. Required bearing should be determined based on specific span conditions.

NOTICE: Design defects that could cause injury or death may result from relying on the information in this document without independent verification by a qualified professional. The information in this document is provided "AS IS". Nucor Corporation and its affiliates expressly disclaim: (i) any and all representations, warranties and conditions and (ii) all liability arising out of or related to this document and the information in it.

1.5BA-36/1.5BIA-36/1.5PLBA-36 ACOUSTICAL ROOF DECKS GRADE 50 STEEL

LRFD

1.5B ACOUSTICAL ROOF DECKS

- 1.5BA-36 Deck used with Side-lap Screws
- 1.5BIA-36 Deck used with TSWs or BPs
- 1.5PLBA-36 Deck used with PunchLok® II System

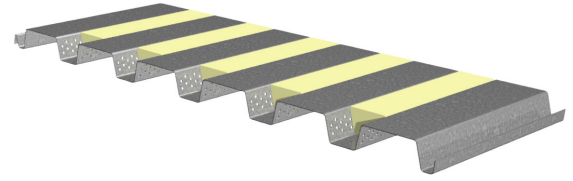

Nominal Dimensions

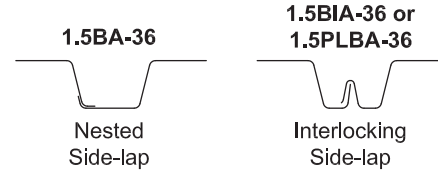
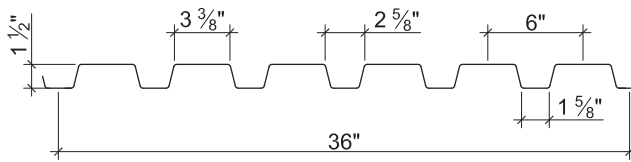

Section Properties

Deck Gage	Deck Weight w_{dd} (psf)	Base Metal Thickness t (in.)	Yield Strength F_y (ksi)	Effective Moment of Inertia at Service Load $I_d = (2I_e + I_g)/3$		Effective Section Modulus at $F_y = 50$ ksi		Design Moment		Vertical Web Shear ϕV_n (lb/ft)
				I_{d+} (in ⁴ /ft)	I_{d-} (in ⁴ /ft)	S_{e+} (in ³ /ft)	S_{e-} (in ³ /ft)	ϕM_{n+} (lb-ft/ft)	ϕM_{n-} (lb-ft/ft)	
22	1.5	0.0295	50	0.148	0.169	0.161	0.170	604	637	3051
20	1.9	0.0358	50	0.187	0.206	0.213	0.218	799	817	3679
19	2.2	0.0418	50	0.227	0.244	0.253	0.264	949	990	4269
18	2.5	0.0474	50	0.263	0.276	0.290	0.302	1087	1132	4812
16	3.2	0.0598	50	0.346	0.348	0.374	0.382	1402	1433	5991

Design Reactions at Supports Based on Web Crippling, ϕR_n (lb/ft)

Deck Gage	Bearing Length of Webs											
	One-Flange Loading						Two-Flange Loading					
	End Bearing				Interior Bearing		End Bearing				Interior Bearing	
	1 1/2"	2"	3"	4"	3"	4"	1 1/2"	2"	3"	4"	3"	4"
22	1199	1318	1517	1656	2195	2373	1220	1315	1473	1583	2666	2899
20	1717	1881	2157	2344	3153	3393	1858	1995	2224	2380	3880	4199
19	2288	2500	2856	3093	4208	4511	2587	2770	3076	3280	5225	5633
18	2888	3149	3587	3870	5317	5681	3376	3606	3992	4242	6644	7138
16	4436	4817	5457	5848	8183	8684	5486	5835	6422	6781	10325	11018

Standard Features

- ASTM A653 SS GR50 Min., with G60 or G90, white or gray primer optional
- ASTM A1008 SS GR50 Min. with gray primer
- Standard lengths – 6'-0" to 42'-0"
- IAPMO UES ER-0652 and FM Listed
- Tables conform to ANSI/SDI RD-2017

Optional Features

- Inquire regarding cost and lead times for:
 - Short cuts < 6'-0"
 - Sheet Lengths > 42'-0"
 - Alternative metallic and painted finishes

1.5BA-36/1.5BIA-36/1.5PLBA-36 ACOUSTICAL ROOF DECKS GRADE 50 STEEL

LRFD

Inward Uniform Design Loads, LRFD (psf)

Deck Gage	Spans	Criteria	Span (ft-in.)										
			2'-0"	3'-0"	4'-0"	5'-0"	6'-0"	7'-0"	8'-0"	9'-0"	10'-0"	11'-0"	12'-0"
22	Single	ϕW_n	1208	537	302	193	134	99	75	60	48	40	34
		L/240	1213	359	152	78	45	28	19	13	10	7	6
	Double	ϕW_n	1130	535	308	200	140	103	79	63	51	42	35
		L/240	3336	988	417	213	124	78	52	37	27	20	15
	Triple	ϕW_n	1350	653	380	247	173	128	98	78	63	52	44
		L/240	2615	775	327	167	97	61	41	29	21	16	12
20	Single	ϕW_n	1598	710	400	256	178	130	100	79	64	53	44
		L/240	1532	454	192	98	57	36	24	17	12	9	7
	Double	ϕW_n	1429	681	394	255	179	132	101	80	65	54	45
		L/240	4066	1205	508	260	151	95	64	45	33	24	19
	Triple	ϕW_n	1700	830	485	316	222	164	126	100	81	67	56
		L/240	3187	944	398	204	118	74	50	35	25	19	15
19	Single	ϕW_n	1897	843	474	304	211	155	119	94	76	63	53
		L/240	1860	551	233	119	69	43	29	20	15	11	9
	Double	ϕW_n	1713	821	475	309	216	159	122	97	79	65	55
		L/240	4816	1427	602	308	178	112	75	53	39	29	22
	Triple	ϕW_n	2032	998	584	382	268	198	152	121	98	81	68
		L/240	3775	1119	472	242	140	88	59	41	30	23	17
18	Single	ϕW_n	2174	966	544	348	242	178	136	107	87	72	60
		L/240	2155	639	269	138	80	50	34	24	17	13	10
	Double	ϕW_n	1952	937	543	353	247	182	140	111	90	74	63
		L/240	5448	1614	681	349	202	127	85	60	44	33	25
	Triple	ϕW_n	2312	1138	667	436	306	227	174	138	112	93	78
		L/240	4270	1265	534	273	158	100	67	47	34	26	20
16	Single	ϕW_n	2804	1246	701	449	312	229	175	138	112	93	78
		L/240	2835	840	354	181	105	66	44	31	23	17	13
	Double	ϕW_n	2459	1183	686	446	312	231	177	140	114	94	79
		L/240	6869	2035	859	440	254	160	107	75	55	41	32
	Triple	ϕW_n	2910	1436	843	551	387	286	220	175	142	117	99
		L/240	5384	1595	673	345	199	126	84	59	43	32	25

Note:

1. Table does not account for web crippling. Required bearing should be determined based on specific span conditions.

NOTICE: Design defects that could cause injury or death may result from relying on the information in this document without independent verification by a qualified professional. The information in this document is provided "AS IS". Nucor Corporation and its affiliates expressly disclaim: (i) any and all representations, warranties and conditions and (ii) all liability arising out of or related to this document and the information in it.

1.5BA-36/1.5BIA-36/1.5PLBA-36 ACOUSTICAL ROOF DECKS GRADE 80 STEEL

LRFD

1.5B ACOUSTICAL ROOF DECKS

- 1.5BA-36 Deck used with Side-lap Screws
- 1.5BIA-36 Deck used with TSWs or BPs
- 1.5PLBA-36 Deck used with PunchLok® II System

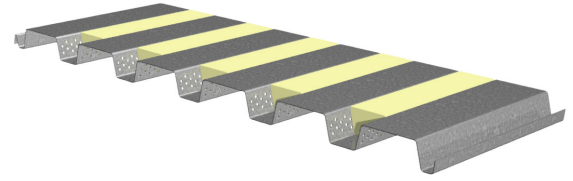

Nominal Dimensions

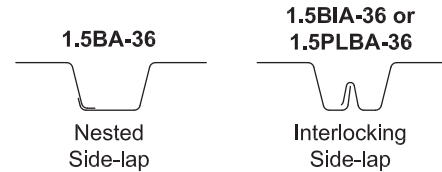
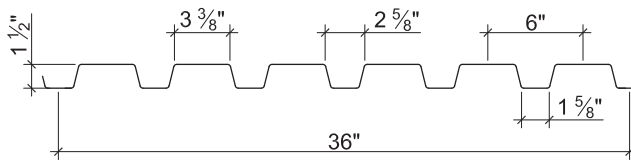

Section Properties

Deck Gage	Deck Weight w_{dd} (psf)	Base Metal Thickness t (in.)	Yield Strength F_y (ksi)	Effective Moment of Inertia at Service Load $I_d = (2I_e + I_g)/3$		Effective Section Modulus at $F_y = 60$ ksi		Design Moment		Vertical Web Shear ϕV_n (lb/ft)
				I_{d+} (in ⁴ /ft)	I_{d-} (in ⁴ /ft)	S_{e+} (in ³ /ft)	S_{e-} (in ³ /ft)	ϕM_{n+} (lb-ft/ft)	ϕM_{n-} (lb-ft/ft)	
22	1.5	0.0295	60	0.144	0.166	0.154	0.164	693	738	3661
20	1.9	0.0358	60	0.183	0.206	0.204	0.212	918	954	4415
19	2.2	0.0418	60	0.221	0.241	0.250	0.257	1125	1157	5122
18	2.5	0.0474	60	0.259	0.276	0.287	0.299	1292	1346	5774

Design Reactions at Supports Based on Web Crippling, ϕR_n (lb/ft)

Deck Gage	Bearing Length of Webs											
	One-Flange Loading						Two-Flange Loading					
	End Bearing				Interior Bearing		End Bearing				Interior Bearing	
	1 1/2"	2"	3"	4"	3"	4"	1 1/2"	2"	3"	4"	3"	4"
22	1438	1581	1820	1987	2635	2848	1464	1578	1767	1900	3200	3478
20	2060	2257	2588	2813	3783	4072	2229	2393	2668	2856	4656	5039
19	2746	3000	3427	3712	5050	5414	3105	3324	3692	3936	6270	6760
18	3465	3778	4304	4645	6381	6817	4051	4327	4791	5091	7972	8566

Standard Features

- ASTM A653 SS GR80, with G60 or G90, white or gray primer optional
- ASTM A1008 SS GR80 with gray primer
- Standard lengths – 6'-0" to 42'-0"
- IAPMO UES ER-0652 and FM Listed
- Tables conform to ANSI/SDI RD-2017

Optional Features

- Inquire regarding cost and lead times for:
 - Short cuts < 6'-0"
 - Sheet Lengths > 42'-0"
 - Alternative metallic and painted finishes

1.5BA-36/1.5BIA-36/1.5PLBA-36 ACOUSTICAL ROOF DECKS GRADE 80 STEEL

LRFD

Inward Uniform Design Loads, LRFD (psf)

Deck Gage	Spans	Criteria	Span (ft-in.)										
			2'-0"	3'-0"	4'-0"	5'-0"	6'-0"	7'-0"	8'-0"	9'-0"	10'-0"	11'-0"	12'-0"
22	Single	ϕW_n	1386	616	347	222	154	113	87	68	55	46	39
		L/240	1180	350	148	76	44	28	18	13	9	7	5
	Double	ϕW_n	1318	622	358	232	162	119	92	72	59	49	41
		L/240	3277	971	410	210	121	76	51	36	26	20	15
	Triple	ϕW_n	1579	761	442	287	201	148	114	90	73	61	51
		L/240	2568	761	321	164	95	60	40	28	21	15	12
20	Single	ϕW_n	1836	816	459	294	204	150	115	91	73	61	51
		L/240	1500	444	187	96	56	35	23	16	12	9	7
	Double	ϕW_n	1679	798	460	298	209	154	118	94	76	63	53
		L/240	4066	1205	508	260	151	95	64	45	33	24	19
	Triple	ϕW_n	2001	973	567	369	259	191	147	117	95	78	66
		L/240	3187	944	398	204	118	74	50	35	25	19	15
19	Single	ϕW_n	2250	1000	563	360	250	184	141	111	90	74	63
		L/240	1811	537	226	116	67	42	28	20	14	11	8
	Double	ϕW_n	2014	962	557	361	253	186	143	113	92	76	64
		L/240	4757	1410	595	304	176	111	74	52	38	29	22
	Triple	ϕW_n	2394	1171	685	447	313	232	178	141	115	95	80
		L/240	3729	1105	466	239	138	87	58	41	30	22	17
18	Single	ϕW_n	2583	1148	646	413	287	211	161	128	103	85	72
		L/240	2122	629	265	136	79	50	33	23	17	13	10
	Double	ϕW_n	2325	1115	646	419	294	217	166	132	107	88	74
		L/240	5448	1614	681	349	202	127	85	60	44	33	25
	Triple	ϕW_n	2757	1355	794	518	364	269	207	164	133	110	93
		L/240	4270	1265	534	273	158	100	67	47	34	26	20

Note:

1. Table does not account for web crippling. Required bearing should be determined based on specific span conditions.

NOTICE: Design defects that could cause injury or death may result from relying on the information in this document without independent verification by a qualified professional. The information in this document is provided "AS IS". Nucor Corporation and its affiliates expressly disclaim: (i) any and all representations, warranties and conditions and (ii) all liability arising out of or related to this document and the information in it.

3NLA-32/3NIA-32/3PLNA-32 ACOUSTICAL ROOF DECKS GRADE 50 STEEL

LRFD

32" WIDE 3N ACOUSTICAL ROOF DECKS

- 3NLA-32 Deck used with Side-lap Screws
- 3NIA-32 Deck used with TSWs or BPs
- 3PLNA-32 Deck used with PunchLok® II System

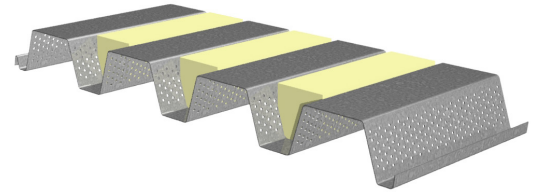

Nominal Dimensions

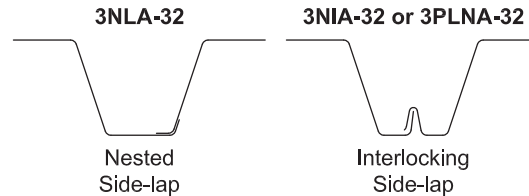
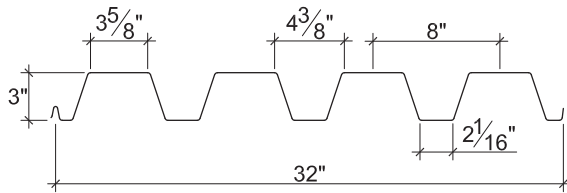

Section Properties

Deck Gage	Deck Weight w_{dd} (psf)	Base Metal Thickness t (in.)	Yield Strength F_y (ksi)	Effective Moment of Inertia at Service Load $I_d = (2I_e + I_g)/3$		Effective Section Modulus at $F_y = 50$ ksi		Design Moment		Vertical Web Shear ϕV_n (lb/ft)
				I_{d+} (in ⁴ /ft)	I_{d-} (in ⁴ /ft)	S_{e+} (in ³ /ft)	S_{e-} (in ³ /ft)	ϕM_{n+} (lb-ft/ft)	ϕM_{n-} (lb-ft/ft)	
22	1.7	0.0295	50	0.611	0.680	0.328	0.353	1230	1324	2480
20	2.1	0.0358	50	0.766	0.842	0.426	0.452	1598	1695	4287
19	2.4	0.0418	50	0.917	1.000	0.526	0.550	1973	2063	5844
18	2.8	0.0474	50	1.067	1.140	0.627	0.641	2352	2404	7521
16	3.5	0.0598	50	1.405	1.448	0.826	0.841	3098	3154	10333

Design Reactions at Supports Based on Web Crippling, ϕR_n (lb/ft)

Deck Gage	Bearing Length of Webs											
	One-Flange Loading						Two-Flange Loading					
	End Bearing				Interior Bearing		End Bearing				Interior Bearing	
	1 1/2"	2"	3"	4"	4"	8"	1 1/2"	2"	3"	4"	4"	8"
22	780	858	988	1097	1752	2037	703	757	848	925	1979	2323
20	1134	1242	1424	1578	2510	3109	1107	1189	1325	1441	2900	3642
19	1525	1666	1903	2103	3342	4206	1577	1688	1875	2032	3920	5012
18	1938	2113	2407	2655	4214	5279	2090	2233	2472	2673	4999	6363
16	3012	3271	3705	4072	6465	8023	3484	3706	4079	4393	7805	9848

Standard Features

- ASTM A653 SS GR50 Min., with G60 or G90, white or gray primer optional
- ASTM A1008 SS GR50 Min. with gray primer
- Standard lengths – 6'-0" to 42'-0"
- IAPMO UES ER-0652 and FM Listed
- Tables conform to ANSI/SDI RD-2017

Optional Features

- Inquire regarding cost and lead times for:
 - Short cuts < 6'-0"
 - Sheet Lengths > 42'-0"
 - Alternative metallic and painted finishes

3NLA-32/3NIA-32/3PLNA-32 ACOUSTICAL ROOF DECKS GRADE 50 STEEL

LRFD

Inward Uniform Design Loads, LRFD (psf)

Deck Gage	Spans	Criteria	Span (ft-in.)										
			4'-0"	6'-0"	8'-0"	9'-0"	10'-0"	11'-0"	12'-0"	14'-0"	16'-0"	18'-0"	20'-0"
22	Single	ϕW_n	615	273	154	122	98	81	68	50	38	30	25
		L/240	626	185	78	55	40	30	23	15	10	7	5
	Double	ϕW_n	551	269	157	125	102	85	72	53	41	32	26
		L/240	1678	497	210	147	107	81	62	39	26	18	13
	Triple	ϕW_n	646	324	192	154	126	105	89	66			
		L/240	1315	390	164	115	84	63	49	31			
20	Single	ϕW_n	799	355	200	158	128	106	89	65	50	39	32
		L/240	785	232	98	69	50	38	29	18	12	9	6
	Double	ϕW_n	760	358	206	163	133	110	93	68	53	42	34
		L/240	2078	616	260	182	133	100	77	48	32	23	17
	Triple	ϕW_n	911	438	254	202	165	137	115	85			
		L/240	1628	482	204	143	104	78	60	38			
19	Single	ϕW_n	986	438	247	195	158	130	110	81	62	49	39
		L/240	939	278	117	82	60	45	35	22	15	10	8
	Double	ϕW_n	944	440	252	200	163	135	113	84	64	51	41
		L/240	2467	731	308	217	158	119	91	58	39	27	20
	Triple	ϕW_n	1139	540	312	248	202	167	141	104			
		L/240	1934	573	242	170	124	93	72	45			
18	Single	ϕW_n	1176	523	294	232	188	155	131	96	73	58	47
		L/240	1093	324	137	96	70	53	40	25	17	12	9
	Double	ϕW_n	1116	516	295	234	190	157	132	97	75	59	48
		L/240	2813	833	352	247	180	135	104	66	44	31	23
	Triple	ϕW_n	1355	636	365	290	236	196	165	122			
		L/240	2205	653	276	194	141	106	82	51			
16	Single	ϕW_n	1549	688	387	306	248	205	172	126	97	76	62
		L/240	1439	426	180	126	92	69	53	34	22	16	12
	Double	ϕW_n	1473	679	387	307	249	207	174	128	98	78	63
		L/240	3573	1059	447	314	229	172	132	83	56	39	29
	Triple	ϕW_n	1792	838	480	382	310	257	216	160			
		L/240	2800	830	350	246	179	135	104	65			

Note:

1. Table does not account for web crippling. Required bearing should be determined based on specific span conditions.

NOTICE: Design defects that could cause injury or death may result from relying on the information in this document without independent verification by a qualified professional. The information in this document is provided "AS IS". Nucor Corporation and its affiliates expressly disclaim: (i) any and all representations, warranties and conditions and (ii) all liability arising out of or related to this document and the information in it.

3NLA-32/3NIA-32/3PLNA-32 ACOUSTICAL ROOF DECKS GRADE 80 STEEL

LRFD

32" WIDE 3N ACOUSTICAL ROOF DECKS

- 3NLA-32 Deck used with Side-lap Screws
- 3NIA-32 Deck used with TSWs or BPs
- 3PLNA-32 Deck used with PunchLok® II System

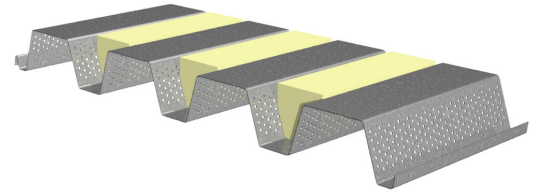

Nominal Dimensions

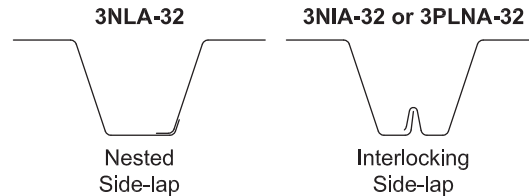
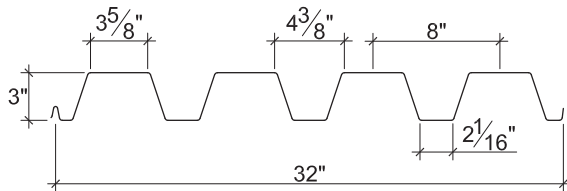

Section Properties

Deck Gage	Deck Weight w_{dd} (psf)	Base Metal Thickness t (in.)	Yield Strength F_y (ksi)	Effective Moment of Inertia at Service Load $I_d = (2I_e + I_g)/3$		Effective Section Modulus at $F_y = 60$ ksi		Design Moment		Vertical Web Shear ϕV_n (lb/ft)
				I_{d+} (in ⁴ /ft)	I_{d-} (in ⁴ /ft)	S_{e+} (in ³ /ft)	S_{e-} (in ³ /ft)	ϕM_{n+} (lb-ft/ft)	ϕM_{n-} (lb-ft/ft)	
22	1.7	0.0295	60	0.604	0.672	0.318	0.329	1431	1481	2480
20	2.1	0.0358	60	0.754	0.832	0.412	0.440	1854	1980	4445
19	2.4	0.0418	60	0.903	0.989	0.509	0.535	2291	2408	6403
18	2.8	0.0474	60	1.048	1.136	0.605	0.626	2723	2817	8238

Design Reactions at Supports Based on Web Crippling, ϕR_n (lb/ft)

Deck Gage	Bearing Length of Webs											
	One-Flange Loading						Two-Flange Loading					
	End Bearing				Interior Bearing		End Bearing				Interior Bearing	
	1 1/2"	2"	3"	4"	4"	8"	1 1/2"	2"	3"	4"	4"	8"
22	937	1029	1185	1316	2102	2444	843	908	1018	1110	2375	2787
20	1361	1491	1709	1893	3013	3730	1329	1427	1590	1729	3480	4370
19	1830	1999	2284	2524	4010	5047	1892	2026	2250	2438	4704	6015
18	2325	2536	2888	3186	5057	6334	2508	2679	2966	3208	5999	7635

Standard Features

- ASTM A653 SS GR80, with G60 or G90, white or gray primer optional
- ASTM A1008 SS GR50 with gray primer
- Standard lengths – 6'-0" to 42'-0"
- IAPMO UES ER-0652 and FM Listed
- Tables conform to ANSI/SDI RD-2017

Optional Features

- Inquire regarding cost and lead times for:
 - Short cuts < 6'-0"
 - Sheet Lengths > 42'-0"
 - Alternative metallic and painted finishes

3NLA-32/3NIA-32/3PLNA-32 ACOUSTICAL ROOF DECKS GRADE 80 STEEL

LRFD

Inward Uniform Design Loads, LRFD (psf)

Deck Gage	Spans	Criteria	Span (ft-in.)										
			4'-0"	6'-0"	8'-0"	9'-0"	10'-0"	11'-0"	12'-0"	14'-0"	16'-0"	18'-0"	20'-0"
22	Single	ϕW_n	716	318	179	141	114	95	80	58	45	35	29
		L/240	619	183	77	54	40	30	23	14	10	7	5
	Double	ϕW_n	593	295	173	139	113	94	80	59	45	36	29
		L/240	1658	491	207	146	106	80	61	39	26	18	13
	Triple	ϕW_n	689	353	211	170	139	116	99	73			
		L/240	1300	385	162	114	83	62	48	30			
20	Single	ϕW_n	927	412	232	183	148	123	103	76	58	46	37
		L/240	772	229	97	68	49	37	29	18	12	8	6
	Double	ϕW_n	865	412	238	190	155	128	108	80	61	49	39
		L/240	2053	608	257	180	131	99	76	48	32	23	16
	Triple	ϕW_n	1029	502	293	234	191	159	134	99			
		L/240	1609	477	201	141	103	77	60	38			
19	Single	ϕW_n	1145	509	286	226	183	151	127	93	72	57	46
		L/240	925	274	116	81	59	44	34	22	14	10	7
	Double	ϕW_n	1089	511	293	233	189	157	132	97	75	59	48
		L/240	2440	723	305	214	156	117	90	57	38	27	20
	Triple	ϕW_n	1311	626	362	288	235	195	164	121			
		L/240	1913	567	239	168	122	92	71	45			
18	Single	ϕW_n	1361	605	340	269	218	180	151	111	85	67	54
		L/240	1073	318	134	94	69	52	40	25	17	12	9
	Double	ϕW_n	1295	602	344	273	222	184	155	114	88	69	56
		L/240	2803	831	350	246	179	135	104	65	44	31	22
	Triple	ϕW_n	1567	740	426	339	276	229	193	142			
		L/240	2197	651	275	193	141	106	81	51			

Note:

1. Table does not account for web crippling. Required bearing should be determined based on specific span conditions.

NOTICE: Design defects that could cause injury or death may result from relying on the information in this document without independent verification by a qualified professional. The information in this document is provided "AS IS". Nucor Corporation and its affiliates expressly disclaim: (i) any and all representations, warranties and conditions and (ii) all liability arising out of or related to this document and the information in it.

3NA-24/3NIA-24 ACOUSTICAL ROOF DECKS

GRADE 40 STEEL

LRFD

24" WIDE 3N ACOUSTICAL ROOF DECKS

- 3NA-24 Deck used with Side-lap Screws
- 3NIA-24 Deck used with TSWs or BPs

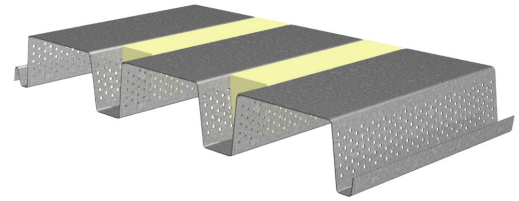

Nominal Dimensions

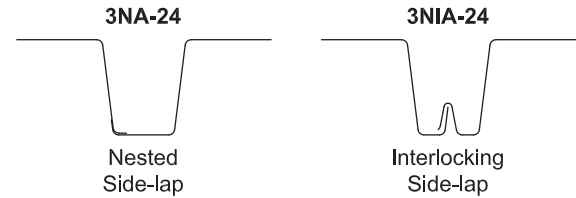
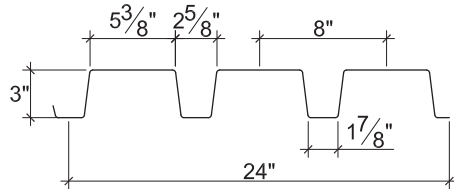

Section Properties

Deck Gage	Deck Weight w_{dd} (psf)	Base Metal Thickness t (in.)	Yield Strength F_y (ksi)	Effective Moment of Inertia at Service Load $I_d = (2I_e + I_g)/3$		Effective Section Modulus at $F_y = 40$ ksi		Design Moment		Vertical Web Shear ϕV_n (lb/ft)
				I_{d+} (in ⁴ /ft)	I_{d-} (in ⁴ /ft)	S_{e+} (in ³ /ft)	S_{e-} (in ³ /ft)	ϕM_{n+} (lb-ft/ft)	ϕM_{n-} (lb-ft/ft)	
22	1.9	0.0295	40	0.679	0.826	0.349	0.398	1047	1194	2760
20	2.4	0.0358	40	0.856	1.017	0.458	0.503	1374	1509	4062
19	2.8	0.0418	40	1.033	1.189	0.555	0.605	1665	1815	5535
18	3.1	0.0474	40	1.204	1.350	0.640	0.695	1920	2085	6484
16	3.9	0.0598	40	1.598	1.705	0.832	0.887	2496	2661	8126

Design Reactions at Supports Based on Web Crippling, ϕR_n (lb/ft)

Deck Gage	Bearing Length of Webs											
	One-Flange Loading						Two-Flange Loading					
	End Bearing				Interior Bearing		End Bearing				Interior Bearing	
	1 1/2"	2"	3"	4"	4"	8"	1 1/2"	2"	3"	4"	4"	8"
22	673	739	851	946	1498	1742	612	659	738	805	1702	1998
20	976	1069	1226	1358	2146	2657	961	1032	1150	1250	2491	3128
19	1312	1433	1637	1809	2856	3595	1366	1462	1624	1760	3366	4304
18	1665	1816	2068	2281	3601	4510	1808	1931	2137	2312	4289	5459
16	2583	2806	3178	3493	5518	6848	3004	3195	3516	3787	6685	8436

Standard Features

- ASTM A653 SS GR40 Min., with G60 or G90, white or gray primer optional
- ASTM A1008 SS GR40 Min. with gray primer
- Standard lengths – 6'-0" to 42'-0"
- IAPMO UES ER-0652 and FM Listed
- Tables conform to ANSI/SDI RD-2017

Optional Features

- Inquire regarding cost and lead times for:
 - Short cuts < 6'-0"
 - Sheet Lengths > 42'-0"
 - Alternative metallic and painted finishes

3NA-24/3NIA-24 ACOUSTICAL ROOF DECKS GRADE 40 STEEL

LRFD

Inward Uniform Design Loads, LRFD (psf)

Deck Gage	Spans	Criteria	Span (ft-in.)										
			4'-0"	6'-0"	8'-0"	9'-0"	10'-0"	11'-0"	12'-0"	14'-0"	16'-0"	18'-0"	20'-0"
22	Single	ϕW_n	523	233	131	103	84	69	58	43	33	26	21
		L/240	696	206	87	61	45	33	26	16	11	8	6
	Double	ϕW_n	525	250	144	115	93	77	65	48	37	29	24
		L/240	2038	604	255	179	130	98	75	48	32	22	16
	Triple	ϕW_n	626	304	177	142	116	96	81	60			
		L/240	1597	473	200	140	102	77	59	37			
20	Single	ϕW_n	687	305	172	136	110	91	76	56	43	34	27
		L/240	877	260	110	77	56	42	32	20	14	10	7
	Double	ϕW_n	684	320	184	146	119	98	83	61	47	37	30
		L/240	2509	744	314	220	161	121	93	59	39	28	20
	Triple	ϕW_n	824	393	227	181	147	122	103	76			
		L/240	1967	583	246	173	126	95	73	46			
19	Single	ϕW_n	833	370	208	164	133	110	93	68	52	41	33
		L/240	1058	314	132	93	68	51	39	25	17	12	8
	Double	ϕW_n	840	389	222	176	143	119	100	74	56	45	36
		L/240	2934	869	367	258	188	141	109	68	46	32	23
	Triple	ϕW_n	1018	479	275	219	178	148	124	92			
		L/240	2299	681	287	202	147	111	85	54			
18	Single	ϕW_n	960	427	240	190	154	127	107	78	60	47	38
		L/240	1233	365	154	108	79	59	46	29	19	14	10
	Double	ϕW_n	967	448	256	203	165	136	115	85	65	51	42
		L/240	3331	987	416	292	213	160	123	78	52	37	27
	Triple	ϕW_n	1174	551	317	252	205	170	143	105			
		L/240	2611	774	326	229	167	126	97	61			
16	Single	ϕW_n	1248	555	312	246	200	165	139	102	78	62	50
		L/240	1637	485	205	144	105	79	61	38	26	18	13
	Double	ϕW_n	1231	571	326	259	210	174	146	108	83	65	53
		L/240	4207	1246	526	369	269	202	156	98	66	46	34
	Triple	ϕW_n	1493	703	404	321	261	217	182	134			
		L/240	3297	977	412	289	211	159	122	77			

Note:

1. Table does not account for web crippling. Required bearing should be determined based on specific span conditions.

NOTICE: Design defects that could cause injury or death may result from relying on the information in this document without independent verification by a qualified professional. The information in this document is provided "AS IS". Nucor Corporation and its affiliates expressly disclaim: (i) any and all representations, warranties and conditions and (ii) all liability arising out of or related to this document and the information in it.

COMPOSITE DECK

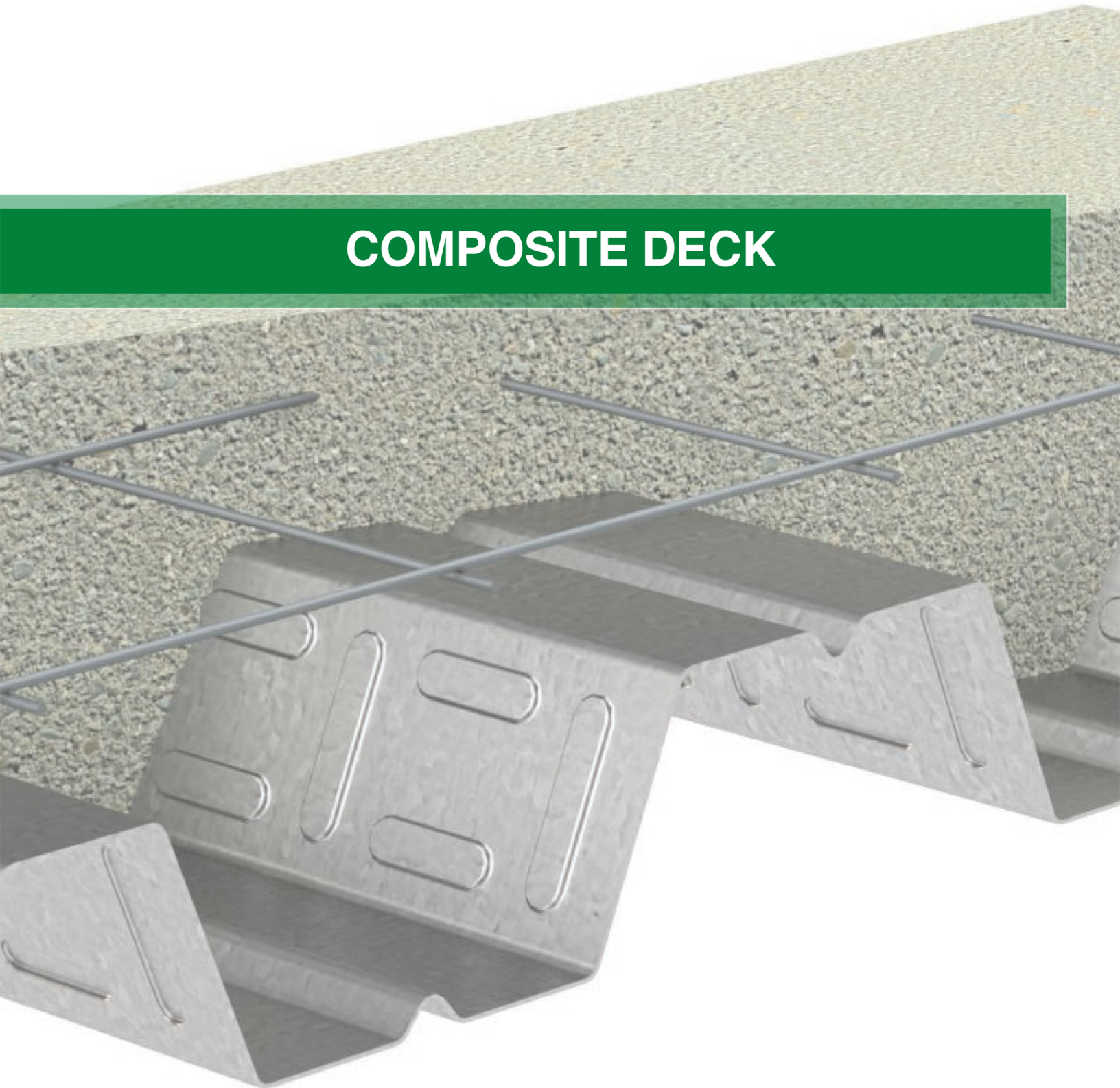

2.0D FORMLOK DOVETAIL DECK

- Enhanced 2-Coat Polyester Paint
- White Factory Primer Paint
- Galvanized Finish
- UL Listed

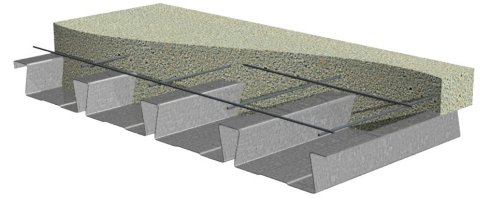

Nominal Dimensions

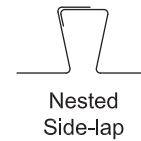
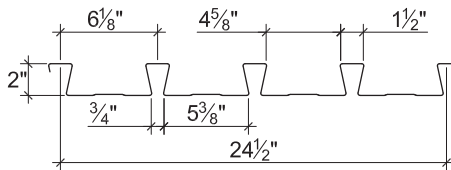

Section Properties

Deck Gage	Deck Weight w_{dd} (psf)	Base Metal Thickness t (in.)	Yield Strength F_y (ksi)	Effective Moment of Inertia at Service Load $I_d = (2I_e + I_g)/3$		Effective Section Modulus at $F_y = 40$ ksi		Design Moment		Vertical Web Shear ϕV_n (lb/ft)
				I_{d+} (in ⁴ /ft)	I_{d-} (in ⁴ /ft)	S_{e+} (in ³ /ft)	S_{e-} (in ³ /ft)	ϕM_{n+} (lb-ft/ft)	ϕM_{n-} (lb-ft/ft)	
22	2.1	0.0295	40	0.387	0.359	0.272	0.272	816	816	4401
20	2.6	0.0358	40	0.472	0.447	0.343	0.334	1029	1002	5316
18	3.4	0.0474	40	0.626	0.612	0.463	0.450	1389	1350	6968
16	4.3	0.0598	40	0.792	0.791	0.587	0.576	1761	1728	8698

Design Reactions at Supports Based on Web Crippling, ϕR_n (lb/ft)

Deck Gage	Bearing Length of Webs											
	One-Flange Loading						Two-Flange Loading					
	End Bearing				Interior Bearing		End Bearing				Interior Bearing	
	1 1/2"	2"	3"	4"	3"	5"	1 1/2"	2"	3"	4"	3"	5"
22	999	1098	1264	1403	1905	2255	1075	1158	1297	1415	2331	2792
20	1425	1561	1790	1982	2712	3192	1618	1737	1937	2105	3358	4001
18	2381	2596	2957	3262	4516	5272	2897	3094	3426	3705	5672	6705
16	3638	3951	4476	4919	6885	7973	4656	4953	5451	5871	8726	10235

Standard Features

- ASTM A653 SS GR 40 Min. with G90
- Standard lengths – 6'-0" to 42'-0"
- Tables conform to ANSI/SDI C-2017
- IAPMO UES ER-423 and UL Listed

Optional Features

- Inquire regarding cost and lead times for:
 - 19 gage
 - Short cuts < 6'-0"
 - Alternative metallic and painted finishes

2.0D FORMLOK® DOVETAIL DECK-SLAB NORMAL WEIGHT CONCRETE (145 pcf)

LRFD

Slab Depth		Maximum Unshored Spans			Composite Deck-Slab Properties				
		Deck Gage	Maximum Unshored Construction Clear Span			Concrete + Deck (psf)	Deflection $I_d = (I_{cr} + I_u)/2$ (in ⁴ /ft)	Moment ϕM_{no} (kip-ft/ft)	Shear ϕV_{no} (kip/ft)
Total	Topping		1	2	3				
4"	2"	22	6'-10"	7'-10"	8'-1"	46.0	5.75	5.12	5.96
		20	7'-11"	8'-8"	8'-11"	46.5	6.16	6.09	5.96
		18	9'-6"	10'-0"	10'-4"	47.3	6.85	7.77	5.96
		16	10'-11"	11'-3"	11'-8"	48.2	7.50	9.48	5.96
5¼"	3¼"	22	6'-2"	7'-1"	7'-4"	61.1	12.19	6.60	7.82
		20	7'-2"	7'-10"	8'-1"	61.6	13.03	7.87	7.82
		18	8'-6"	9'-1"	9'-4"	62.4	14.42	10.10	7.82
		16	9'-9"	10'-2"	10'-6"	63.3	15.75	12.38	7.82
5½"	3½"	22	6'-1"	6'-11"	7'-2"	64.1	13.87	6.90	8.03
		20	7'-0"	7'-8"	7'-11"	64.6	14.81	8.23	8.19
		18	8'-5"	8'-11"	9'-2"	65.4	16.39	10.57	8.19
		16	9'-7"	10'-0"	10'-4"	66.3	17.90	12.98	8.19

Note:

- Maximum unshored spans do not consider web-crippling. Required bearing should be determined based on specific span conditions.

Superimposed Design Load, ϕW_n , / Deflection at L/360 (psf) NWC (145 pcf), $f'_c = 3000$ psi

Total Slab Depth	Deck Gage	Span (ft-in.)							
		10'-0"	12'-0"	13'-0"	14'-0"	15'-0"	16'-0"	18'-0"	20'-0"
4"	22	354/251	229/145	187/114	153/91	126/74	104/61	71/43	47/31
	20	430/269	282/155	232/122	192/98	160/79	134/65	94/46	65/33
	18	564/299	374/173	311/136	260/109	219/88	186/73	135/51	98/37
	16	700/327	469/189	391/149	329/119	279/97	238/80	176/56	131/40
5¼"	22	454/532	293/308	239/242	196/194	161/157	132/130	89/91	58/66
	20	555/569	363/329	298/259	247/207	205/168	171/138	120/97	83/71
	18	732/630	485/364	403/286	337/229	284/186	240/153	174/108	127/78
	16	914/688	611/398	510/313	429/250	364/203	310/168	229/118	171/86
5½"	22	475/606	306/350	249/275	204/220	168/179	138/148	93/103	61/75
	20	580/647	379/374	312/294	258/235	215/191	179/158	125/111	87/80
	18	767/716	508/414	422/325	353/260	297/212	251/174	182/122	132/89
	16	958/782	641/452	534/355	450/285	381/231	326/190	240/134	180/97

Notes:

- For high loads long term concrete creep should be considered.
- Use Composite Deck-Slab Strength Web Based Solutions for alternate slabs or ASD design.

2.0D FORMLOK® DOVETAIL DECK-SLAB LIGHT WEIGHT CONCRETE (110 pcf)

LRFD

Slab Depth		Maximum Unshored Spans			Composite Deck-Slab Properties				
		Deck Gage	Maximum Unshored Construction Clear Span			Concrete + Deck (psf)	Deflection $I_d = (I_{cr} + I_u)/2$ (in ⁴ /ft)	Moment ϕM_{no} (kip-ft/ft)	Shear ϕV_{no} (kip/ft)
Total	Topping		1	2	3				
4"	2"	22	7'-7"	8'-8"	8'-11"	35.4	4.43	4.91	5.96
		20	8'-9"	9'-6"	9'-10"	35.9	4.79	5.81	5.96
		18	10'-6"	11'-0"	11'-5"	36.7	5.36	7.38	5.96
		16	11'-10"	12'-5"	12'-10"	37.6	5.89	8.96	5.96
4½"	2½"	22	7'-3"	8'-4"	8'-7"	40.0	6.11	5.48	6.45
		20	8'-5"	9'-2"	9'-6"	40.5	6.59	6.49	6.70
		18	10'-1"	10'-7"	10'-11"	41.3	7.36	8.26	6.70
		16	11'-6"	11'-11"	12'-4"	42.2	8.09	10.05	6.70
5¼"	3¼"	22	6'-10"	7'-10"	8'-1"	46.9	9.33	6.36	6.87
		20	7'-11"	8'-8"	9'-0"	47.4	10.04	7.55	7.69
		18	9'-6"	10'-0"	10'-4"	48.2	11.21	9.64	7.82
		16	10'-11"	11'-4"	11'-8"	49.1	12.30	11.77	7.82

Note:

- Maximum unshored spans do not consider web-crippling. Required bearing should be determined based on specific span conditions.

Total Slab Depth		Deck Gage	Superimposed Design Load, ϕW_p , / Deflection at L/360 (psf)							LWC (110 pcf), $f'_c = 3000$ psi
			Span (ft-in.)							
			10'-0"	12'-0"	13'-0"	14'-0"	15'-0"	16'-0"	18'-0"	20'-0"
4"	22		350/193	230/112	189/88	157/70	131/57	110/47	78/33	55/24
	20		421/209	279/121	231/95	193/76	163/61	138/51	100/35	73/26
	18		546/234	365/135	305/106	257/85	218/69	186/57	138/40	103/29
	16		671/257	452/149	379/117	320/93	273/76	234/62	176/44	134/32
4½"	22		390/267	256/154	211/121	175/97	146/79	123/65	87/45	61/33
	20		470/287	311/166	258/131	216/104	182/85	154/70	111/49	81/35
	18		611/321	409/186	341/146	287/117	244/95	208/78	154/55	115/40
	16		753/353	507/204	425/160	359/128	306/104	263/86	197/60	150/44
5¼"	22		452/407	296/236	244/185	203/148	169/120	142/99	100/69	70/50
	20		547/438	362/254	300/199	251/159	211/130	179/107	129/75	94/54
	18		713/489	477/283	398/222	335/178	284/145	243/119	180/83	135/61
	16		882/537	594/311	498/244	421/195	359/159	308/131	231/92	176/67

Notes:

- For high loads long term concrete creep should be considered.
- Use Composite Deck-Slab Strength Web Based Solutions for alternate slabs or ASD design.

2.0D FORMLOK® DOVETAIL DECK-SLAB

LRFD

2.0D FormLok Deck-Slab Information

$f'_c = 3000$ psi

Total Slab Depth (in.)	Cover Depth (in.)	Theoretical Concrete Volume (yd ³ /100 ft ²)	Min. A _s for T&S (in. ²)	Recommended Reinforcing for Temperature and Shrinkage	
				WWR	(OR) Bekaert Dramix® Steel Fiber Alternate to WWR (lb/yd ³)
4D 65/60BG					
Normal Weight Concrete (145 pcf)					
4	2	1.12	0.028	6x6-W1.4xW1.4	23
4½	2½	1.28	0.028	6x6-W1.4xW1.4	18
4¾	2¾	1.35	0.028	6x6-W1.4xW1.4	16
5	3	1.43	0.028	6x6-W1.4xW1.4	15
5¼	3¼	1.51	0.029	6x6-W2.1xW2.1	15
5½	3½	1.58	0.032	6x6-W2.1xW2.1	15
6	4	1.74	0.036	6x6-W2.1xW2.1	15
6¾	4¾	1.97	0.043	6x6-W2.9xW2.9	15
Light Weight Concrete (110 pcf)					
4	2	1.12	0.028	6X6-W1.4xW1.4	33
4½	2½	1.28	0.028	6x6-W1.4xW1.4	25
5	3	1.43	0.028	6x6-W1.4xW1.4	20
5¼	3¼	1.51	0.029	6x6-W2.1xW2.1	20
5½	3½	1.58	0.032	6x6-W2.1xW2.1	20
6	4	1.74	0.036	6x6-W2.1xW2.1	20

Notes:

1. FRC reinforcement is based on IAPMO UES ER-465.
2. Dramix® fibers may be used in UL or ULC fire rated assemblies in lieu of WWR. See UL file R19307 for additional information.

For information on Bekaert Dramix® fibers contact 770-514-2295 or infobuilding@bekaert.com.

NOTICE: Design defects that could cause injury or death may result from relying on the information in this document without independent verification by a qualified professional. The information in this document is provided "AS IS". Nucor Corporation and its affiliates expressly disclaim: (i) any and all representations, warranties and conditions and (ii) all liability arising out of or related to this document and the information in it.

3.5D FORMLOK® DOVETAIL DECK

LRFD

3.5D FORMLOK DOVETAIL DECK

- Enhanced 2-Coat Polyester Paint
- White Factory Primer Paint
- Galvanized Finish
- UL Listed

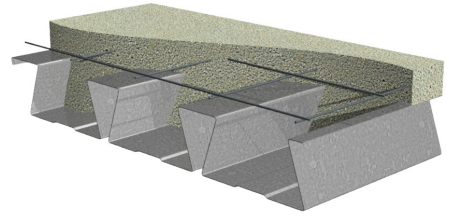

Nominal Dimensions

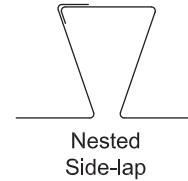
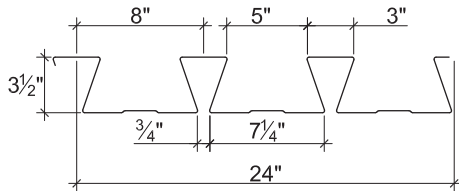

Section Properties

Deck Gage	Deck Weight w_{dd} (psf)	Base Metal Thickness t (in.)	Yield Strength F_y (ksi)	Effective Moment of Inertia at Service Load $I_d = (2I_e + I_g)/3$		Effective Section Modulus at $F_y = 40$ ksi		Design Moment		Vertical Web Shear ϕV_n (lb/ft)
				I_{d+} (in ⁴ /ft)	I_{d-} (in ⁴ /ft)	S_{e+} (in ³ /ft)	S_{e-} (in ³ /ft)	ϕM_{n+} (lb-ft/ft)	ϕM_{n-} (lb-ft/ft)	
20	3.3	0.0358	40	1.762	1.646	0.676	0.781	2028	2343	5221
18	4.3	0.0474	40	2.415	2.272	0.980	1.070	2940	3210	9138
16	5.4	0.0598	40	3.133	2.968	1.317	1.377	3951	4131	12635

Design Reactions at Supports Based on Web Crippling, ϕR_n (lb/ft)

Deck Gage	Bearing Length of Webs											
	One-Flange Loading						Two-Flange Loading					
	End Bearing				Interior Bearing		End Bearing				Interior Bearing	
	2"	3"	4"	5"	4"	6"	2"	3"	4"	5"	4"	6"
20	1060	1215	1346	1461	2170	2484	1092	1218	1324	1417	2564	2962
18	1787	2035	2245	2429	3602	4096	2004	2219	2399	2559	4354	4998
16	2744	3108	3416	3687	5475	6191	3270	3599	3876	4120	6717	7671

Standard Features

- ASTM A653 SS GR 40 Min. with G90
- Standard lengths – 6'-0" to 42'-0"
- Tables conform to ANSI/SDI C-2017
- IAPMO UES ER-423 and UL Listed

Optional Features

- Inquire regarding cost and lead times for:
 - 19 gage
 - Short cuts < 6'-0"
 - Alternative metallic and painted finishes

3.5D FORMLOK® DOVETAIL DECK-SLAB NORMAL WEIGHT CONCRETE (145 pcf)

LRFD

		Maximum Unshored Spans			Composite Deck-Slab Properties				
Slab Depth	Deck Gage	Maximum Unshored Construction Clear Span			Concrete + Deck (psf)	Deflection $I_d = (I_{cr} + I_u)/2$ (in ⁴ /ft)	Moment ϕM_{no} (kip-ft/ft)	Shear ϕV_{no} (kip/ft)	
		1	2	3					
Total	Topping								
5½"	2"	20	10'-10"	12'-0"	12'-5"	59.9	14.40	10.22	6.78
		18	13'-4"	14'-1"	14'-7"	60.9	15.99	13.00	6.78
		16	14'-9"	15'-11"	16'-5"	62.0	17.61	15.35	6.78
5¾"	2¼"	20	10'-8"	11'-10"	12'-2"	62.9	16.27	10.60	7.09
		18	13'-1"	13'-10"	14'-3"	63.9	18.03	13.58	7.09
		16	14'-7"	15'-8"	16'-2"	65.0	19.75	16.51	7.09
6"	2½"	20	10'-5"	11'-7"	12'-0"	65.9	18.29	10.99	7.39
		18	12'-10"	13'-7"	14'-0"	66.9	20.24	14.09	7.39
		16	14'-5"	15'-4"	15'-10"	68.0	22.14	17.25	7.39

Note:

1. Maximum unshored spans do not consider web-crippling. Required bearing should be determined based on specific span conditions.

Superimposed Design Load, ϕW_n , / Deflection at L/360 (psf) NWC (145 pcf), $f'_c = 3000$ psi

Total Slab Depth	Deck Gage	Span (ft-in.)							
		15'-0"	17'-0"	18'-0"	19'-0"	20'-0"	21'-0"	23'-0"	25'-0"
5½"	20	291/186	211/128	180/107	154/91	132/78	113/67	82/51	58/40
	18	389/207	286/142	248/119	215/101	187/87	162/75	123/57	93/44
	16	471/228	350/156	304/131	265/112	232/96	204/83	157/63	122/49
5¾"	20	301/210	217/144	186/121	159/103	136/88	116/76	84/58	60/45
	18	406/233	299/160	258/135	224/114	194/98	169/85	128/64	97/50
	16	509/255	379/175	329/147	287/125	252/107	221/93	171/70	133/55
6"	20	311/236	225/162	192/137	164/116	140/99	120/86	87/65	61/51
	18	420/262	309/180	267/151	231/128	201/110	175/95	132/72	100/56
	16	531/286	395/196	344/165	300/141	263/120	231/104	179/79	139/61

Notes:

1. For high loads long term concrete creep should be considered.
2. Use Composite Deck-Slab Strength Web Based Solutions for alternate slabs or ASD design.

3.5D FORMLOK® DOVETAIL DECK-SLAB LIGHT WEIGHT CONCRETE (110 pcf)

LRFD

		Maximum Unshored Spans			Composite Deck-Slab Properties				
Slab Depth		Deck Gage	Maximum Unshored Construction Clear Span			Concrete + Deck (psf)	Deflection $I_d = (I_{cr} + I_u)/2$ (in ⁴ /ft)	Moment ϕM_{no} (kip-ft/ft)	Shear ϕV_{no} (kip/ft)
Total	Topping		1	2	3				
5½"	2"	20	12'-1"	13'-4"	13'-9"	46.2	11.18	9.48	6.78
		18	14'-10"	15'-7"	16'-1"	47.2	12.69	11.69	6.78
		16	15'-9"	17'-7"	18'-2"	48.3	14.26	14.04	6.78
5¾"	2¼"	20	11'-11"	13'-1"	13'-7"	48.5	12.57	10.13	7.09
		18	14'-8"	15'-4"	15'-10"	49.5	14.13	12.42	7.09
		16	15'-7"	17'-4"	17'-10"	50.6	15.75	14.70	7.09
8"	4½"	20	10'-3"	11'-5"	11'-10"	69.1	31.09	13.86	8.37
		18	12'-8"	13'-5"	13'-10"	70.1	34.56	17.73	9.86
		16	14'-4"	15'-2"	15'-8"	71.2	37.85	21.67	9.86

Note:

1. Maximum unshored spans do not consider web-crippling. Required bearing should be determined based on specific span conditions.

Superimposed Design Load, ϕW_n , / Deflection at L/360 (psf) LWC (110 pcf), $f'_c = 3000$ psi

Total Slab Depth	Deck Gage	Span (ft-in.)							
		15'-0"	17'-0"	18'-0"	19'-0"	20'-0"	21'-0"	23'-0"	25'-0"
5½"	20	281/144	206/99	178/83	154/71	134/61	116/52	87/40	65/31
	18	359/164	267/112	232/95	202/80	177/69	155/59	120/45	93/35
	16	441/184	330/126	288/106	253/90	222/77	196/67	154/51	121/39
5¾"	20	301/162	222/111	191/94	166/80	144/68	125/59	94/45	71/35
	18	382/182	284/125	247/105	215/90	188/77	165/66	128/50	99/39
	16	462/203	346/140	302/118	265/100	233/86	205/74	161/56	127/44
8"	20	409/402	300/276	259/233	224/198	194/169	168/146	126/111	94/86
	18	546/447	406/307	353/258	308/220	270/188	237/163	183/124	142/96
	16	685/490	514/336	449/283	394/241	347/206	307/178	242/135	191/105

Notes:

1. For high loads long term concrete creep should be considered.
2. Use Composite Deck-Slab Strength Web Based Solutions for alternate slabs or ASD design.

3.5D FORMLOK® DOVETAIL DECK-SLAB

LRFD

3.5D FormLok Deck-Slab Information

$f'_c = 3000$ psi

Total Slab Depth (in.)	Cover Depth (in.)	Theoretical Concrete Volume (yd ³ /100 ft ²)	Min. A _s for T&S (in. ²)	Recommended Reinforcing for Temperature and Shrinkage	
				WWR	(OR) Bekaert Dramix® Steel Fiber Alternate to WWR (lb/yd ³)
Normal Weight Concrete (145 pcf)					
5½	2	1.44	0.028	6x6-W1.4xW1.4	23
5¾	2¼	1.52	0.028	6x6-W1.4xW1.4	20
6	2½	1.60	0.028	6x6-W1.4xW1.4	18
6½	3	1.75	0.028	6x6-W1.4xW1.4	15
7	3½	1.91	0.032	6x6-W2.1xW2.1	15
7¼	3¾	1.98	0.034	6x6-W2.1xW2.1	15
7½	4	2.06	0.036	6x6-W2.1xW2.1	15
8	4½	2.22	0.041	6x6-W2.1xW2.1	15
Light Weight Concrete (110 pcf)					
5½	2	1.44	0.028	6x6-W1.4xW1.4	33
5¾	2¼	1.52	0.028	6x6-W1.4xW1.4	28
6	2½	1.60	0.028	6x6-W1.4xW1.4	25
6½	3	1.75	0.028	6x6-W1.4xW1.4	20
7	3½	1.91	0.032	6x6-W2.1xW2.1	20
7½	4	2.06	0.036	6x6-W2.1xW2.1	20
8	4½	2.22	0.041	6x6-W2.1xW2.1	20

Notes:

1. FRC reinforcement is based on IAPMO UES ER-465.
2. Dramix® fibers may be used in UL or ULC fire rated assemblies in lieu of WWR. See UL file R19307 for additional information.

For information on Bekaert Dramix® fibers contact 770-514-2295 or infobuilding@bekaert.com.

NOTICE: Design defects that could cause injury or death may result from relying on the information in this document without independent verification by a qualified professional. The information in this document is provided "AS IS". Nucor Corporation and its affiliates expressly disclaim: (i) any and all representations, warranties and conditions and (ii) all liability arising out of or related to this document and the information in it.

1.5VL-36/1.5VLI-36/1.5PLVLI-36 COMPOSITE DECKS

GRADE 50 STEEL

LRFD

1.5VL COMPOSITE DECKS

- 1.5VL-36 Deck used with Side-lap Screws
- 1.5VLI-36 Deck used with TSWs or BPs
- 1.5PLVLI-36 Deck used with PunchLok® II System

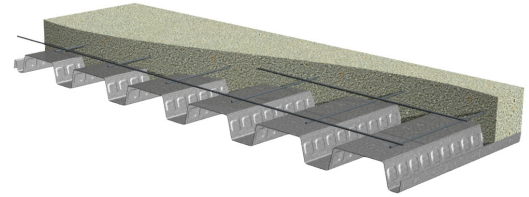

Nominal Dimensions

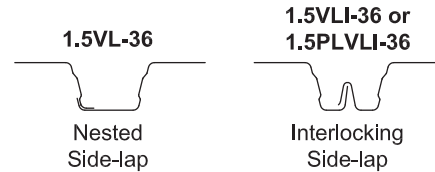
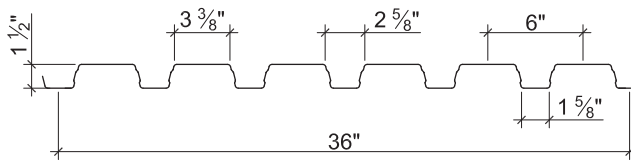

Section Properties

Deck Gage	Deck Weight w_{dd} (psf)	Base Metal Thickness t (in.)	Yield Strength F_y (ksi)	Effective Moment of Inertia at Service Load $I_d = (2I_e + I_g)/3$		Effective Section Modulus at $F_y = 50$ ksi		Design Moment		Vertical Web Shear ϕV_n (lb/ft)
				I_{d+} (in ⁴ /ft)	I_{d-} (in ⁴ /ft)	S_{e+} (in ³ /ft)	S_{e-} (in ³ /ft)	ϕM_n+ (lb-ft/ft)	ϕM_n- (lb-ft/ft)	
22	1.6	0.0295	50	0.155	0.178	0.169	0.179	634	671	4035
20	2.0	0.0358	50	0.197	0.217	0.224	0.229	840	859	4874
19	2.3	0.0418	50	0.239	0.257	0.266	0.278	997	1042	5666
18	2.6	0.0474	50	0.277	0.290	0.306	0.318	1148	1193	6398
16	3.3	0.0598	50	0.364	0.367	0.393	0.402	1474	1508	7996

Design Reactions at Supports Based on Web Crippling, ϕR_n (lb/ft)

Deck Gage	Bearing Length of Webs											
	One-Flange Loading						Two-Flange Loading					
	End Bearing				Interior Bearing		End Bearing				Interior Bearing	
	1 1/2"	2"	3"	4"	3"	4"	1 1/2"	2"	3"	4"	3"	4"
22	1235	1357	1563	1706	2204	2383	1289	1389	1556	1672	2728	2966
20	1763	1932	2215	2408	3164	3406	1949	2093	2333	2497	3960	4286
19	2344	2562	2927	3169	4222	4527	2702	2893	3213	3426	5324	5740
18	2954	3221	3669	3959	5334	5699	3515	3754	4156	4417	6762	7265
16	4525	4915	5568	5967	8206	8709	5681	6043	6651	7023	10487	11191

Standard Features

- ASTM A653 SS GR50 Min., with G60 or G90, white or gray primer bottom optional
- ASTM A1008 SS GR50 Min. with gray primer bottom
- Standard lengths – 6'-0" to 42'-0"
- IAPMO UES ER-0652 and UL Listed
- Tables conform to ANSI/SDI C-2017

Optional Features

- Inquire regarding cost and lead times for:
 - Short cuts < 6'-0"
 - Sheet Lengths > 42'-0"
 - Alternative metallic and painted finishes
- Factory Hanger Tabs

1.5VL-36/1.5VLI-36/1.5PLVLI-36 COMPOSITE DECK-SLABS

NORMAL WEIGHT CONCRETE (145 pcf)

LRFD

			Maximum Unshored Spans			Composite Deck-Slab Properties			
Slab Depth		Deck Gage	Maximum Unshored Construction Clear Span			Concrete + Deck (psf)	Deflection $I_d = (I_{cr} + I_u)/2$ (in ⁴ /ft)	Moment ϕM_{no} (kip-ft/ft)	Shear ϕV_{no} (kip/ft)
Total	Topping		1	2	3				
3½"	2"	22	6'-6"	7'-7"	7'-8"	32.2	2.64	2.73	3.02
		20	7'-10"	9'-0"	9'-3"	32.6	2.85	3.22	3.02
		19	8'-4"	9'-11"	10'-3"	32.9	3.03	3.67	3.02
		18	8'-9"	10'-7"	10'-11"	33.2	3.19	4.07	3.02
		16	9'-6"	11'-10"	11'-8"	33.9	3.52	4.91	3.02
5"	3½"	22	5'-8"	6'-7"	6'-8"	50.3	7.62	4.79	4.93
		20	6'-9"	7'-9"	7'-11"	50.7	8.18	5.69	4.93
		19	7'-3"	8'-7"	8'-10"	51.0	8.68	6.54	4.93
		18	7'-8"	9'-2"	9'-5"	51.3	9.12	7.30	4.93
		16	8'-4"	10'-3"	10'-4"	52.0	10.02	8.92	4.93
6"	4½"	22	5'-3"	6'-1"	6'-2"	62.4	13.11	6.30	6.41
		20	6'-3"	7'-2"	7'-4"	62.8	14.02	7.51	6.41
		19	6'-10"	7'-11"	8'-2"	63.1	14.85	8.64	6.41
		18	7'-2"	8'-5"	8'-9"	63.4	15.57	9.67	6.41
		16	7'-10"	9'-6"	9'-8"	64.1	17.06	11.87	6.41

Note:

1. Maximum unshored spans do not consider web-crippling. Required bearing should be determined based on specific span conditions.

Superimposed Design Load, ϕW_n , / Deflection at L/360 (psf)

NWC (145 pcf), $f'_c = 3000$ psi

Total Slab Depth	Deck Gage	Span (ft-in.)							
		4'-0"	5'-0"	6'-0"	7'-0"	8'-0"	9'-0"	10'-0"	12'-0"
3½"	22	1327/1804	835/923	568/534	407/336	302/225	231/158	179/115	113/66
	20	1471/1944	990/995	676/576	486/362	363/243	278/170	218/124	139/72
	19	1471/2071	1135/1060	776/613	560/386	419/258	323/181	254/132	164/76
	18	1471/2179	1168/1115	864/645	624/406	469/272	362/191	285/139	186/80
	16	1470/2401	1168/1229	966/711	761/448	573/300	444/210	352/153	232/88
5"	22	2336/5206	1473/2665	1004/1542	722/971	538/650	412/457	323/333	205/192
	20	2405/5585	1761/2859	1204/1654	868/1042	650/698	501/490	394/357	255/206
	19	2404/5929	1911/3035	1391/1756	1006/1106	756/741	584/520	461/379	302/219
	18	2404/6228	1911/3188	1559/1845	1129/1162	850/778	659/546	522/398	343/230
	16	2403/6842	1910/3503	1581/2027	1346/1276	1052/855	818/600	651/437	433/253
6"	22	3075/8955	1941/4585	1325/2653	953/1670	712/1119	547/786	429/573	275/331
	20	3130/9574	2327/4902	1593/2836	1150/1786	863/1196	666/840	525/612	341/354
	19	3129/10137	2488/5190	1845/3003	1335/1891	1004/1267	777/889	615/648	404/375
	18	3129/10630	2488/5443	2060/3149	1502/1983	1132/1328	878/933	697/680	461/393
	16	3128/11651	2487/5965	2060/3452	1754/2174	1407/1456	1095/1022	873/745	582/431

Notes:

1. For high loads long term concrete creep should be considered.
2. Use Composite Deck-Slab Strength Web Based Solutions for alternate slabs or ASD design.

1.5VL-36/1.5VLI-36/1.5PLVLI-36 COMPOSITE DECK-SLABS

LIGHT WEIGHT CONCRETE (110 pcf)

LRFD

			Maximum Unshored Spans			Composite Deck-Slab Properties			
Slab Depth		Deck Gage	Maximum Unshored Construction Clear Span			Concrete + Deck (psf)	Deflection $I_d = (I_{cr} + I_u)/2$ (in ⁴ /ft)	Moment ϕM_{no} (kip-ft/ft)	Shear ϕV_{no} (kip/ft)
Total	Topping		1	2	3				
3½"	2"	22	7'-1"	8'-4"	8'-5"	24.8	2.07	2.58	3.02
		20	8'-7"	9'-10"	10'-2"	25.2	2.24	3.03	3.02
		19	9'-2"	10'-10"	11'-2"	25.5	2.39	3.44	3.02
		18	9'-7"	11'-6"	11'-10"	25.8	2.52	3.80	3.02
		16	10'-5"	12'-11"	12'-5"	26.5	2.79	4.56	3.02
4"	2½"	22	6'-9"	7'-11"	8'-0"	29.4	3.06	3.18	3.62
		20	8'-1"	9'-4"	9'-7"	29.8	3.31	3.75	3.62
		19	8'-8"	10'-3"	10'-8"	30.1	3.54	4.27	3.62
		18	9'-1"	11'-0"	11'-4"	30.4	3.73	4.73	3.62
		16	9'-10"	12'-3"	12'-0"	31.1	4.12	5.71	3.62
4¾"	3¼"	22	6'-4"	7'-5"	7'-6"	36.3	5.07	4.23	4.59
		20	7'-7"	8'-9"	9'-0"	36.7	5.48	5.00	4.59
		19	8'-2"	9'-8"	9'-11"	37.0	5.85	5.72	4.59
		18	8'-6"	10'-3"	10'-8"	37.3	6.17	6.36	4.59
		16	9'-3"	11'-6"	11'-5"	38.0	6.81	7.71	4.59

Note:

1. Maximum unshored spans do not consider web-crippling. Required bearing should be determined based on specific span conditions.

Superimposed Design Load, ϕW_n , / Deflection at L/360 (psf)

LWC (110 pcf), $f'_c = 3000$ psi

Total Slab Depth	Deck Gage	Span (ft-in.)							
		4'-0"	5'-0"	6'-0"	7'-0"	8'-0"	9'-0"	10'-0"	12'-0"
3½"	22	1262/1410	797/722	544/417	392/263	293/176	225/123	176/90	113/52
	20	1480/1528	939/782	643/452	464/285	348/191	268/134	212/97	138/56
	19	1480/1634	1071/837	734/484	531/305	399/204	309/143	244/104	160/60
	18	1479/1723	1177/882	814/510	589/321	444/215	344/151	273/110	180/63
	16	1479/1904	1176/975	975/564	712/355	538/238	418/167	332/121	221/70
4"	22	1556/2088	983/1069	671/618	484/389	362/261	279/183	219/133	141/77
	20	1772/2260	1163/1157	796/669	576/421	432/282	334/198	264/144	172/83
	19	1772/2415	1330/1236	913/715	661/450	497/301	385/212	305/154	201/89
	18	1772/2546	1410/1303	1015/754	736/475	555/318	431/223	342/162	226/94
	16	1771/2811	1409/1439	1168/833	894/524	676/351	526/246	419/179	279/104
4¾"	22	2072/3463	1310/1773	896/1026	647/646	485/432	374/304	294/221	191/128
	20	2249/3745	1556/1917	1067/1109	772/698	581/468	450/328	356/239	233/138
	19	2249/3997	1785/2046	1226/1184	889/745	670/499	520/350	413/255	273/148
	18	2249/4213	1790/2157	1367/1248	993/786	749/526	583/369	463/269	308/156
	16	2248/4649	1789/2380	1483/1377	1213/867	918/581	715/408	571/297	382/172

Notes:

1. For high loads long term concrete creep should be considered.
2. Use Composite Deck-Slab Strength Web Based Solutions for alternate slabs or ASD design.

1.5VL-36/1.5VLI-36/1.5PLVLI-36 COMPOSITE DECK-SLABS

LRFD

1.5VL-36/1.5VLI-36/1.5PLVLI-36 Composite Deck-Slab Information

$f'_c = 3000$ psi

Total Slab Depth (in.)	Cover Depth (in.)	Theoretical Concrete Volume (yd ³ /100 ft ²)	Min. A _s for T&S (in. ²)	Recommended Reinforcing for Temperature and Shrinkage	
				WWR	(OR) Bekaert Dramix® Steel Fiber Alternate to WWR (lb/yd ³)
4D 65/60BG					
Normal Weight Concrete (145 pcf)					
3½	2	0.78	0.028	6x6-W1.4xW1.4	23
4	2½	0.94	0.028	6x6-W1.4xW1.4	18
4½	3	1.09	0.028	6x6-W1.4xW1.4	15
5	3½	1.24	0.032	6x6-W2.1xW2.1	15
5½	4	1.40	0.036	6x6-W2.1xW2.1	15
6	4½	1.55	0.041	6x6-W2.1xW2.1	15
Light Weight Concrete (110 pcf)					
3½	2	0.78	0.028	6x6-W1.4xW1.4	33
4	2½	0.94	0.028	6x6-W1.4xW1.4	25
4½	3	1.09	0.028	6x6-W1.4xW1.4	20
4¾	3¼	1.17	0.029	6x6-W2.1xW2.1	20
5	3½	1.24	0.032	6x6-W2.1xW2.1	20
5¾	4¼	1.48	0.038	6x6-W2.1xW2.1	20

Notes:

1. FRC reinforcement is based on IAPMO UES ER-465.
2. Dramix® fibers may be used in UL or ULC fire rated assemblies in lieu of WWR. See UL file R19307 for additional information.

For information on Bekaert Dramix® fibers contact 770-514-2295 or infobuilding@bekaert.com.

NOTICE: Design defects that could cause injury or death may result from relying on the information in this document without independent verification by a qualified professional. The information in this document is provided "AS IS". Nucor Corporation and its affiliates expressly disclaim: (i) any and all representations, warranties and conditions and (ii) all liability arising out of or related to this document and the information in it.

1.5VLR-36 COMPOSITE DECK GRADE 50 STEEL

LRFD

1.5VLR COMPOSITE DECK

- 1.5VLR-36 Deck used with Side-lap Screws

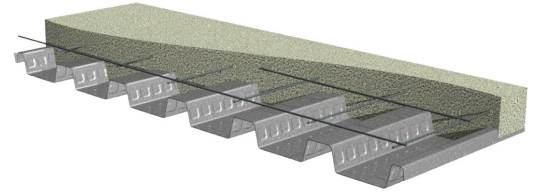

Nominal Dimensions

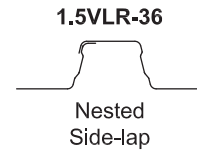
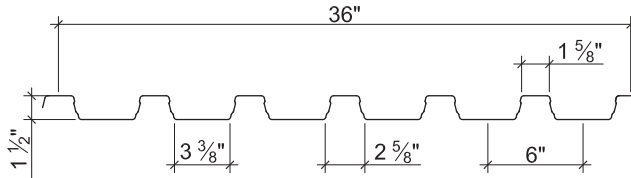

Section Properties

Deck Gage	Deck Weight w_{dd} (psf)	Base Metal Thickness t (in.)	Yield Strength F_y (ksi)	Effective Moment of Inertia at Service Load $I_d = (2I_e + I_g)/3$		Effective Section Modulus at $F_y = 50$ ksi		Design Moment		Vertical Web Shear ϕV_n (lb/ft)
				I_{d+} (in ⁴ /ft)	I_{d-} (in ⁴ /ft)	S_{e+} (in ³ /ft)	S_{e-} (in ³ /ft)	ϕM_{n+} (lb-ft/ft)	ϕM_{n-} (lb-ft/ft)	
22	1.6	0.0295	50	0.178	0.155	0.179	0.169	671	634	4035
20	2.0	0.0358	50	0.217	0.197	0.229	0.224	859	840	4874
19	2.3	0.0418	50	0.257	0.239	0.278	0.266	1042	997	5666
18	2.6	0.0474	50	0.290	0.277	0.318	0.306	1193	1148	6398
16	3.3	0.0598	50	0.367	0.364	0.402	0.393	1508	1474	7996

Design Reactions at Supports Based on Web Crippling, ϕR_n (lb/ft)

Deck Gage	Bearing Length of Webs											
	One-Flange Loading						Two-Flange Loading					
	End Bearing				Interior Bearing		End Bearing				Interior Bearing	
	1 1/2"	2"	3"	4"	3"	4"	1 1/2"	2"	3"	4"	3"	4"
22	1235	1357	1563	1706	2204	2383	1289	1389	1556	1672	2728	2966
20	1763	1932	2215	2408	3164	3406	1949	2093	2333	2497	3960	4286
19	2344	2562	2927	3169	4222	4527	2702	2893	3213	3426	5324	5740
18	2954	3221	3669	3959	5334	5699	3515	3754	4156	4417	6762	7265
16	4525	4915	5568	5967	8206	8709	5681	6043	6651	7023	10487	11191

Standard Features

- ASTM A653 SS GR50 Min., with G60 or G90, white or gray primer bottom optional
- ASTM A1008 SS GR50 Min. with gray primer bottom
- Standard lengths – 6'-0" to 42'-0"
- IAPMO UES ER-0652 and UL Listed
- Tables conform to ANSI/SDI C-2017

Optional Features

- Inquire regarding cost and lead times for:
 - Short cuts < 6'-0"
 - Sheet Lengths > 42'-0"
 - Alternative metallic and painted finishes

1.5VLR-36 COMPOSITE DECK-SLABS NORMAL WEIGHT CONCRETE (145 pcf)

LRFD

			Maximum Unshored Spans			Composite Deck-Slab Properties			
Slab Depth		Deck Gage	Maximum Unshored Construction Clear Span			Concrete + Deck (psf)	Deflection $I_d = (I_{cr} + I_u)/2$ (in ⁴ /ft)	Moment ϕM_{no} (kip-ft/ft)	Shear ϕV_{no} (kip/ft)
Total	Topping		1	2	3				
3½"	2"	22	6'-5"	7'-5"	7'-8"	37.5	3.43	3.86	5.03
		20	7'-7"	8'-6"	8'-9"	37.9	3.68	4.58	5.03
		19	8'-2"	9'-3"	9'-7"	38.2	3.91	5.25	5.03
		18	8'-6"	9'-11"	10'-3"	38.5	4.11	5.85	5.03
		16	9'-2"	11'-2"	11'-3"	39.2	4.50	7.12	5.03
5"	3½"	22	5'-8"	6'-5"	6'-8"	55.6	9.34	5.65	7.51
		20	6'-7"	7'-5"	7'-8"	56.0	9.97	6.74	7.81
		19	7'-3"	8'-1"	8'-4"	56.3	10.55	7.77	7.81
		18	7'-6"	8'-8"	8'-11"	56.6	11.05	8.69	7.81
		16	8'-1"	9'-9"	10'-0"	57.3	12.09	10.68	7.81
6"	4½"	22	5'-3"	6'-0"	6'-2"	67.7	15.62	7.20	8.36
		20	6'-2"	6'-11"	7'-1"	68.1	16.63	8.60	9.11
		19	6'-10"	7'-6"	7'-9"	68.4	17.55	9.92	9.49
		18	7'-1"	8'-0"	8'-4"	68.7	18.36	11.12	9.49
		16	7'-8"	9'-1"	9'-5"	69.4	20.03	13.72	9.49

Note:

- Maximum unshored spans do not consider web-crippling. Required bearing should be determined based on specific span conditions.

Superimposed Design Load, ϕW_n , / Deflection at L/360 (psf)

NWC (145 pcf), $f'_c = 3000$ psi

Total Slab Depth	Deck Gage	Span (ft-in.)							
		4'-0"	5'-0"	6'-0"	7'-0"	8'-0"	9'-0"	10'-0"	12'-0"
3½"	22	1886/2344	1191/1200	813/694	585/437	437/293	336/205	264/150	169/86
	20	2244/2515	1420/1287	972/745	702/469	527/314	406/220	320/160	208/93
	19	2471/2670	1634/1367	1121/791	811/498	610/333	472/234	374/170	245/98
	18	2471/2803	1825/1435	1253/830	908/523	684/350	531/246	421/179	278/103
	16	2470/3074	1966/1574	1536/911	1116/573	843/384	656/269	522/196	348/113
5"	22	2760/6375	1742/3264	1189/1889	856/1189	640/796	491/559	385/408	247/236
	20	3304/6809	2090/3486	1431/2017	1033/1270	775/851	598/597	472/435	307/252
	19	3815/7203	2417/3688	1658/2134	1200/1344	903/900	699/632	553/461	363/266
	18	3835/7546	2713/3863	1863/2235	1350/1408	1018/943	790/662	627/482	414/279
	16	3834/8253	3054/4225	2305/2445	1675/1539	1266/1031	986/724	785/528	524/305
6"	22	3516/10667	2221/5461	1517/3160	1093/1990	818/1333	629/936	494/682	318/395
	20	4218/11357	2670/5815	1829/3365	1322/2119	993/1419	767/997	606/726	396/420
	19	4663/11986	3093/6137	2123/3551	1538/2236	1158/1498	898/1052	711/767	469/443
	18	4663/12537	3477/6419	2389/3714	1733/2339	1308/1567	1016/1100	807/802	535/464
	16	4662/13681	3713/7004	2966/4053	2157/2552	1632/1710	1272/1201	1014/875	679/506

Notes:

- For high loads long term concrete creep should be considered.
- Use Composite Deck-Slab Strength Web Based Solutions for alternate slabs or ASD design.

1.5VLR-36 COMPOSITE DECK-SLABS

LIGHT WEIGHT CONCRETE (110 pcf)

LRFD

			Maximum Unshored Spans			Composite Deck-Slab Properties			
Slab Depth		Deck Gage	Maximum Unshored Construction Clear Span			Concrete + Deck (psf)	Deflection $I_d = (I_{cr} + I_u)/2$ (in ⁴ /ft)	Moment ϕM_{no} (kip-ft/ft)	Shear ϕV_{no} (kip/ft)
Total	Topping		1	2	3				
3½"	2"	22	7'-0"	8'-1"	8'-4"	28.8	2.66	3.70	5.03
		20	8'-4"	9'-4"	9'-7"	29.2	2.87	4.37	5.03
		19	8'-11"	10'-2"	10'-6"	29.5	3.06	4.99	5.03
		18	9'-3"	10'-10"	11'-2"	29.8	3.22	5.55	5.03
		16	10'-0"	12'-3"	12'-0"	30.5	3.54	6.72	5.03
4"	2½"	22	6'-9"	7'-9"	8'-0"	33.4	3.85	4.25	5.83
		20	7'-11"	8'-11"	9'-2"	33.8	4.15	5.03	5.92
		19	8'-6"	9'-8"	10'-0"	34.1	4.42	5.76	5.92
		18	8'-10"	10'-4"	10'-8"	34.4	4.65	6.41	5.92
		16	9'-6"	11'-8"	11'-7"	35.1	5.11	7.79	5.92
4¾"	3¼"	22	6'-4"	7'-3"	7'-6"	40.3	6.20	5.10	6.35
		20	7'-5"	8'-4"	8'-8"	40.7	6.68	6.06	7.11
		19	8'-1"	9'-1"	9'-5"	41.0	7.11	6.95	7.32
		18	8'-4"	9'-9"	10'-1"	41.3	7.47	7.75	7.32
		16	9'-0"	11'-0"	11'-1"	42.0	8.22	9.46	7.32

Note:

- Maximum unshored spans do not consider web-crippling. Required bearing should be determined based on specific span conditions.

Superimposed Design Load, ϕW_n , / Deflection at L/360 (psf)

LWC (110 pcf), $f'_c = 3000$ psi

Total Slab Depth	Deck Gage	Span (ft-in.)							
		4'-0"	5'-0"	6'-0"	7'-0"	8'-0"	9'-0"	10'-0"	12'-0"
3½"	22	1814/1815	1149/929	787/537	569/338	427/226	330/159	261/116	170/67
	20	2149/1959	1362/1003	935/580	678/365	510/244	396/172	314/125	207/72
	19	2461/2089	1562/1069	1074/619	779/389	588/261	457/183	364/133	242/77
	18	2481/2198	1738/1125	1196/651	869/410	657/274	511/193	407/140	272/81
	16	2480/2420	1977/1239	1456/717	1060/451	803/302	627/212	501/154	336/89
4"	22	2086/2626	1320/1344	905/778	654/490	491/328	379/230	300/168	196/97
	20	2476/2833	1570/1450	1078/839	781/528	588/354	456/248	362/181	239/104
	19	2840/3018	1803/1545	1239/894	899/563	679/377	528/264	420/193	279/111
	18	2917/3174	2010/1625	1383/940	1005/592	760/396	591/278	471/203	314/117
	16	2916/3492	2325/1788	1689/1034	1229/651	931/436	727/306	581/223	390/129
4¾"	22	2503/4234	1584/2168	1085/1254	784/790	589/529	455/371	359/271	235/156
	20	2979/4561	1889/2335	1297/1351	940/851	708/570	549/400	435/291	287/168
	19	3425/4853	2174/2485	1494/1438	1085/905	819/606	637/426	506/310	336/179
	18	3610/5104	2429/2613	1671/1512	1215/952	918/638	715/448	570/326	380/189
	16	3609/5612	2877/2873	2052/1662	1494/1047	1132/701	884/492	706/359	475/207

Notes:

- For high loads long term concrete creep should be considered.
- Use Composite Deck-Slab Strength Web Based Solutions for alternate slabs or ASD design.

1.5VLR-36 COMPOSITE DECK-SLABS

LRFD

1.5VL-36/1.5VLI-36/1.5PLVLI-36 Composite Deck-Slab Information

$f'_c = 3000$ psi

Total Slab Depth (in.)	Cover Depth (in.)	Theoretical Concrete Volume (yd ³ /100 ft ²)	Min. A _s for T&S (in. ²)	Recommended Reinforcing for Temperature and Shrinkage	
				WWR	(OR) Bekaert Dramix® Steel Fiber Alternate to WWR (lb/yd ³)
				4D 65/60BG	
Normal Weight Concrete (145 pcf)					
3½	2	0.78	0.028	6x6-W1.4xW1.4	23
4	2½	0.94	0.028	6x6-W1.4xW1.4	18
4½	3	1.09	0.028	6x6-W1.4xW1.4	15
5	3½	1.24	0.032	6x6-W2.1xW2.1	15
5½	4	1.40	0.036	6x6-W2.1xW2.1	15
6	4½	1.55	0.041	6x6-W2.1xW2.1	15
Light Weight Concrete (110 pcf)					
3½	2	0.78	0.028	6x6-W1.4xW1.4	33
4	2½	0.94	0.028	6x6-W1.4xW1.4	25
4½	3	1.09	0.028	6x6-W1.4xW1.4	20
4¾	3¼	1.17	0.029	6x6-W2.1xW2.1	20
5	3½	1.24	0.032	6x6-W2.1xW2.1	20
5¾	4¼	1.48	0.038	6x6-W2.1xW2.1	20

Notes:

1. FRC reinforcement is based on IAPMO UES ER-465.
2. Dramix® fibers may be used in UL or ULC fire rated assemblies in lieu of WWR. See UL file R19307 for additional information.

For information on Bekaert Dramix® fibers contact 770-514-2295 or infobuilding@bekaert.com.

NOTICE: Design defects that could cause injury or death may result from relying on the information in this document without independent verification by a qualified professional. The information in this document is provided "AS IS". Nucor Corporation and its affiliates expressly disclaim: (i) any and all representations, warranties and conditions and (ii) all liability arising out of or related to this document and the information in it.

2VLI-36/2VLJ-36/2PLVLI-36 COMPOSITE DECKS

GRADE 50 STEEL

LRFD

2VLI COMPOSITE DECKS

- 2VLI Deck-36 used with TSWs or BPs
- 2VLJ Deck-36 used with Side-lap Screws
- 2PLVLI Deck-36 used with PunchLok® II System

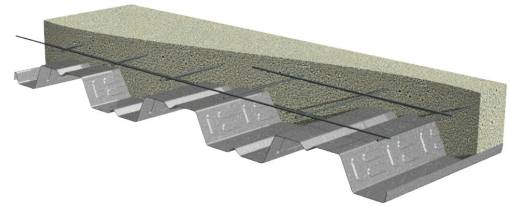

Nominal Dimensions

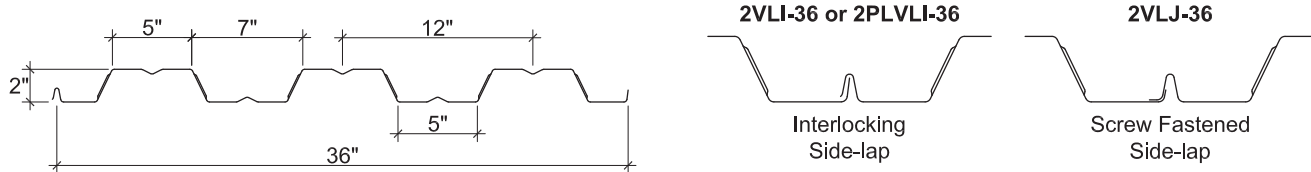

Section Properties

Deck Gage	Deck Weight w_{dd} (psf)	Base Metal Thickness t (in.)	Yield Strength F_y (ksi)	Effective Moment of Inertia at Service Load $I_d = (2I_e + I_g)/3$		Effective Section Modulus at $F_y = 50$ ksi		Design Moment		Vertical Web Shear ϕV_n (lb/ft)
				I_{d+} (in ⁴ /ft)	I_{d-} (in ⁴ /ft)	S_{e+} (in ³ /ft)	S_{e-} (in ³ /ft)	ϕM_n+ (lb-ft/ft)	ϕM_n- (lb-ft/ft)	
22	1.6	0.0295	50	0.324	0.324	0.244	0.255	915	957	2495
20	1.9	0.0358	50	0.409	0.407	0.326	0.337	1222	1264	3677
19	2.2	0.0418	50	0.490	0.488	0.409	0.421	1534	1579	4352
18	2.5	0.0474	50	0.557	0.557	0.485	0.500	1819	1875	4925
16	3.2	0.0598	50	0.703	0.703	0.643	0.652	2411	2445	6185

Design Reactions at Supports Based on Web Crippling, ϕR_n (lb/ft)

Deck Gage	Bearing Length of Webs											
	One-Flange Loading						Two-Flange Loading					
	End Bearing				Interior Bearing		End Bearing				Interior Bearing	
	1½"	2"	3"	4"	4"	6"	1½"	2"	3"	4"	4"	6"
22	556	611	703	781	1141	1312	554	597	668	729	1374	1593
20	798	874	1002	1110	1634	1869	848	910	1015	1103	1997	2306
19	1065	1164	1330	1469	2174	2480	1185	1269	1409	1527	2685	3091
18	1345	1467	1671	1843	2741	3117	1550	1656	1833	1982	3410	3914
16	2071	2249	2548	2800	4202	4751	2530	2691	2962	3190	5287	6037

Standard Features

- ASTM A653 SS GR50 Min., with G60 or G90, white or gray primer bottom optional
- ASTM A1008 SS GR50 Min. with gray primer bottom
- Standard lengths – 6'-0" to 42'-0"
- IAPMO UES ER-0652 and UL Listed
- Tables conform to ANSI/SDI C-2017

Optional Features

- Inquire regarding cost and lead times for:
 - Short cuts < 6'-0"
 - Sheet Lengths > 42'-0"
 - Alternative metallic and painted finishes
- Factory Hanger Tabs

2VLI-36/2VLJ-36/2PLVLI-36 COMPOSITE DECK-SLABS

NORMAL WEIGHT CONCRETE (145 pcf)

LRFD

			Maximum Unshored Spans			Composite Deck-Slab Properties			
Slab Depth		Deck Gage	Maximum Unshored Construction Clear Span			Concrete + Deck (psf)	Deflection $I_d = (I_{cr} + I_u)/2$ (in ⁴ /ft)	Moment ϕM_{no} (kip-ft/ft)	Shear ϕV_{no} (kip/ft)
Total	Topping		1	2	3				
4"	2"	22	7'-10"	9'-0"	9'-3"	37.9	4.14	3.59	4.53
		20	9'-5"	10'-4"	10'-8"	38.2	4.43	4.25	4.60
		19	10'-1"	11'-7"	11'-11"	38.5	4.68	4.86	4.60
		18	10'-6"	12'-7"	12'-7"	38.8	4.92	5.42	4.60
		16	11'-4"	14'-1"	13'-3"	39.5	5.39	6.59	4.60
5½"	3½"	22	6'-10"	7'-10"	8'-1"	56.0	10.32	5.15	5.73
		20	8'-2"	9'-0"	9'-4"	56.3	11.00	6.13	6.79
		19	9'-0"	10'-1"	10'-5"	56.6	11.60	7.03	7.00
		18	9'-4"	11'-0"	11'-4"	56.9	12.14	7.86	7.00
		16	10'-1"	12'-6"	12'-1"	57.6	13.25	9.62	7.00
6½"	4½"	22	6'-5"	7'-3"	7'-6"	68.1	16.78	6.55	6.64
		20	7'-7"	8'-4"	8'-8"	68.4	17.83	7.82	7.70
		19	8'-5"	9'-4"	9'-8"	68.7	18.77	8.99	8.30
		18	8'-9"	10'-2"	10'-6"	69.0	19.61	10.07	8.81
		16	9'-6"	11'-7"	11'-7"	69.7	21.36	11.77	8.81

Note:

- Maximum unshored spans do not consider web-crippling. Required bearing should be determined based on specific span conditions.

Superimposed Design Load, ϕW_n , / Deflection at L/360 (psf)

NWC (145 pcf), $f'_c = 3000$ psi

Total Slab Depth	Deck Gage	Span (ft-in.)							
		6'-0"	7'-0"	8'-0"	9'-0"	10'-0"	11'-0"	12'-0"	14'-0"
4"	22	752/837	540/527	403/353	309/248	241/180	192/135	154/104	101/65
	20	899/895	648/563	485/377	374/265	294/193	235/145	190/111	127/70
	19	1034/947	747/596	561/399	434/280	342/204	275/153	224/118	152/74
	18	1157/994	837/626	630/419	488/294	386/214	311/161	254/124	174/78
	16	1417/1090	1029/686	776/459	603/323	480/235	388/176	318/136	221/85
5½"	22	1077/2088	774/1315	576/881	441/618	345/451	273/338	219/261	143/164
	20	1294/2224	933/1401	698/938	537/659	422/480	337/361	272/278	182/175
	19	1494/2347	1080/1478	811/990	626/695	494/507	397/380	322/293	219/184
	18	1677/2456	1214/1546	913/1036	707/727	560/530	451/398	368/307	252/193
	16	2068/2681	1501/1688	1133/1131	881/794	700/579	566/435	465/335	323/211
6½"	22	1373/3395	987/2138	737/1432	565/1006	442/733	351/551	282/424	185/267
	20	1655/3607	1194/2271	895/1521	690/1068	543/779	434/585	352/450	237/283
	19	1916/3798	1385/2391	1041/1602	805/1125	637/820	512/616	417/474	284/298
	18	2155/3968	1561/2498	1176/1674	911/1175	722/857	583/643	476/496	328/312
	16	2532/4321	1838/2721	1387/1823	1078/1280	858/933	694/701	570/540	396/340

Notes:

- For high loads long term concrete creep should be considered.
- Use Composite Deck-Slab Strength Web Based Solutions for alternate slabs or ASD design.

2VLI-36/2VLJ-36/2PLVLI-36 COMPOSITE DECK-SLABS

LIGHT WEIGHT CONCRETE (110 pcf)

LRFD

			Maximum Unshored Spans			Composite Deck-Slab Properties			
Slab Depth		Deck Gage	Maximum Unshored Construction Clear Span			Concrete + Deck (psf)	Deflection $I_d = (I_{cr} + I_u)/2$ (in ⁴ /ft)	Moment ϕM_{no} (kip-ft/ft)	Shear ϕV_{no} (kip/ft)
Total	Topping		1	2	3				
4"	2"	22	8'-8"	9'-10"	10'-2"	29.1	3.19	3.43	3.96
		20	10'-5"	11'-4"	11'-9"	29.4	3.44	4.05	4.60
		19	11'-1"	12'-8"	13'-0"	29.7	3.66	4.61	4.60
		18	11'-5"	13'-9"	13'-5"	30.0	3.85	5.13	4.60
		16	12'-1"	15'-0"	14'-2"	30.7	4.25	6.21	4.60
4½"	2½"	22	8'-3"	9'-5"	9'-9"	33.7	4.44	3.92	4.24
		20	9'-11"	10'-10"	11'-3"	34.0	4.78	4.63	5.30
		19	10'-7"	12'-1"	12'-6"	34.3	5.08	5.29	5.36
		18	11'-0"	13'-2"	13'-0"	34.6	5.35	5.88	5.36
		16	11'-8"	14'-6"	13'-8"	35.3	5.89	7.13	5.36
5¼"	3¼"	22	7'-9"	8'-10"	9'-2"	40.6	6.89	4.69	4.70
		20	9'-4"	10'-2"	10'-6"	40.9	7.40	5.56	5.76
		19	10'-0"	11'-5"	11'-9"	41.2	7.86	6.36	6.36
		18	10'-5"	12'-5"	12'-5"	41.5	8.27	7.08	6.58
		16	11'-2"	13'-11"	13'-1"	42.2	9.09	8.61	6.58

Note:

- Maximum unshored spans do not consider web-crippling. Required bearing should be determined based on specific span conditions.

Superimposed Design Load, ϕW_n , / Deflection at L/360 (psf)

LWC (110 pcf), $f'_c = 3000$ psi

Total Slab Depth	Deck Gage	Span (ft-in.)							
		6'-0"	7'-0"	8'-0"	9'-0"	10'-0"	11'-0"	12'-0"	14'-0"
4"	22	727/644	525/405	394/271	304/190	239/139	191/104	155/80	105/50
	20	864/695	625/437	470/293	364/205	288/150	232/112	189/86	129/54
	19	989/740	717/466	541/312	420/219	333/159	269/120	220/92	152/58
	18	1103/779	801/491	604/329	470/231	374/168	302/126	248/97	173/61
	16	1342/860	976/542	739/363	576/255	459/185	373/139	308/107	216/67
4½"	22	830/898	599/565	449/378	346/266	273/194	218/145	177/112	119/70
	20	988/967	715/609	538/408	416/286	329/208	265/156	216/120	148/76
	19	1133/1028	821/647	619/433	480/304	381/222	308/166	252/128	174/80
	18	1264/1082	918/681	693/456	539/320	428/233	347/175	285/135	198/85
	16	1541/1192	1121/750	848/503	661/353	528/257	429/193	353/149	248/93
5¼"	22	994/1393	717/877	538/587	414/412	326/300	261/226	212/174	142/109
	20	1186/1497	858/943	645/631	500/443	395/323	318/243	259/187	177/117
	19	1363/1590	988/1001	745/671	578/471	459/343	370/258	303/198	210/125
	18	1523/1672	1105/1053	835/705	649/495	516/361	418/271	343/209	239/131
	16	1863/1839	1355/1158	1026/775	800/545	638/397	518/298	427/229	300/144

Notes:

- For high loads long term concrete creep should be considered.
- Use Composite Deck-Slab Strength Web Based Solutions for alternate slabs or ASD design.

2VLI-36/2VLJ-36/2PLVLI-36 COMPOSITE DECK-SLABS

LRFD

2VLI-36/2VLJ-36/2PLVLI-36 Composite Deck-Slab Information

$f'_c = 3000$ psi

Total Slab Depth (in.)	Cover Depth (in.)	Theoretical Concrete Volume (yd ³ /100 ft ²)	Min. A _s for T&S (in. ²)	Recommended Reinforcing for Temperature and Shrinkage	
				WWR	(OR) Bekaert Dramix® Steel Fiber Alternate to WWR (lb/yd ³)
4D 65/60BG					
Normal Weight Concrete (145 pcf)					
4	2	0.93	0.028	6x6-W1.4xW1.4	23
4½	2½	1.08	0.028	6x6-W1.4xW1.4	18
5	3	1.23	0.028	6x6-W1.4xW1.4	15
5½	3½	1.39	0.032	6x6-W2.1xW2.1	15
6	4	1.54	0.036	6x6-W2.1xW2.1	15
6½	4½	1.70	0.041	6x6-W2.1xW2.1	15
Light Weight Concrete (110 pcf)					
4	2	0.93	0.028	6x6-W1.4xW1.4	33
4½	2½	1.08	0.028	6x6-W1.4xW1.4	25
5	3	1.23	0.028	6x6-W1.4xW1.4	20
5¼	3¼	1.31	0.029	6x6-W2.1xW2.1	20
5½	3½	1.39	0.032	6x6-W2.1xW2.1	20
6¼	4¼	1.62	0.038	6x6-W2.1xW2.1	20

Notes:

1. FRC reinforcement is based on IAPMO UES ER-465.
2. Dramix® fibers may be used in UL or ULC fire rated assemblies in lieu of WWR. See UL file R19307 for additional information.

For information on Bekaert Dramix® fibers contact 770-514-2295 or infobuilding@bekaert.com.

NOTICE: Design defects that could cause injury or death may result from relying on the information in this document without independent verification by a qualified professional. The information in this document is provided "AS IS". Nucor Corporation and its affiliates expressly disclaim: (i) any and all representations, warranties and conditions and (ii) all liability arising out of or related to this document and the information in it.

3VLI-36/3VLJ-36/3PLVLI-36 COMPOSITE DECKS

GRADE 50 STEEL

LRFD

3VLI COMPOSITE DECKS

- 3VLI-36 Deck used with TSWs or BPs
- 3VLJ-36 Deck used with Side-lap Screws
- 3PLVLI-36 Deck used with PunchLok® II System

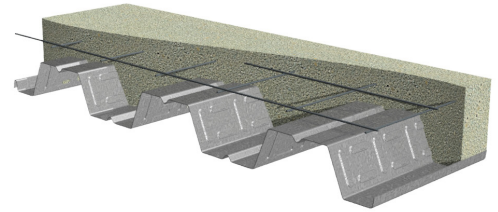

Nominal Dimensions

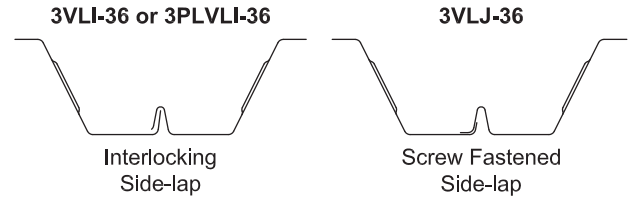
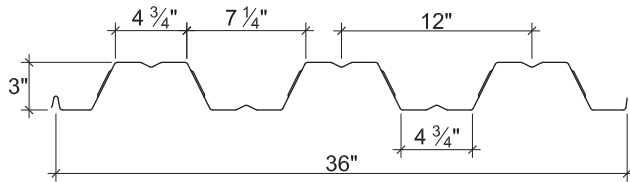

Section Properties

Deck Gage	Deck Weight w_{dd} (psf)	Base Metal Thickness t (in.)	Yield Strength F_y (ksi)	Effective Moment of Inertia at Service Load $I_d = (2I_e + I_p)/3$		Effective Section Modulus at $F_y = 50$ ksi		Design Moment		Vertical Web Shear ϕV_n (lb/ft)
				I_{d+} (in ⁴ /ft)	I_{d-} (in ⁴ /ft)	S_{e+} (in ³ /ft)	S_{e-} (in ³ /ft)	ϕM_{n+} (lb-ft/ft)	ϕM_{n-} (lb-ft/ft)	
22	1.7	0.0295	50	0.732	0.737	0.387	0.410	1452	1537	2138
20	2.1	0.0358	50	0.919	0.921	0.512	0.539	1920	2021	3777
19	2.4	0.0418	50	1.099	1.101	0.639	0.669	2397	2509	5152
18	2.7	0.0474	50	1.253	1.253	0.761	0.794	2854	2977	6628
16	3.5	0.0598	50	1.580	1.580	1.013	1.013	3799	3799	9312

Design Reactions at Supports Based on Web Crippling, ϕR_n (lb/ft)

Deck Gage	Bearing Length of Webs											
	One-Flange Loading						Two-Flange Loading					
	End Bearing				Interior Bearing		End Bearing				Interior Bearing	
	1 1/2"	2"	3"	4"	4"	8"	1 1/2"	2"	3"	4"	4"	8"
22	540	593	683	759	1164	1354	510	549	615	671	1353	1588
20	780	855	980	1085	1668	2065	792	851	948	1031	1975	2481
19	1046	1143	1305	1443	2221	2795	1119	1198	1330	1442	2665	3407
18	1324	1444	1645	1814	2798	3504	1473	1573	1742	1883	3389	4314
16	2049	2226	2521	2771	4291	5324	2430	2585	2845	3065	5275	6656

Standard Features

- ASTM A653 SS GR50 Min., with G60 or G90, white or gray primer bottom optional
- ASTM A1008 SS GR50 Min. with gray primer bottom
- Standard lengths – 6'-0" to 42'-0"
- IAPMO UES ER-0652 and UL Listed
- Tables conform to ANSI/SDI C-2017

Optional Features

- Inquire regarding cost and lead times for:
 - Short cuts < 6'-0"
 - Sheet Lengths > 42'-0"
 - Alternative metallic and painted finishes
- Factory Hanger Tabs

3VLI-36/3VLJ-36/3PLVLI-36 COMPOSITE DECK-SLABS

NORMAL WEIGHT CONCRETE (145 pcf)

LRFD

			Maximum Unshored Spans			Composite Deck-Slab Properties			
Slab Depth		Deck Gage	Maximum Unshored Construction Clear Span			Concrete + Deck (psf)	Deflection $I_d = (I_{cr} + I_u)/2$ (in ⁴ /ft)	Moment ϕM_{no} (kip-ft/ft)	Shear ϕV_{no} (kip/ft)
Total	Topping		1	2	3				
5"	2"	22	10'-0"	10'-7"	11'-0"	44.0	7.54	5.16	4.72
		20	11'-9"	12'-5"	12'-10"	44.4	8.04	6.14	5.61
		19	12'-3"	13'-10"	14'-3"	44.7	8.49	7.03	5.61
		18	12'-8"	15'-1"	14'-10"	45.0	8.89	7.86	5.61
		16	13'-4"	16'-8"	15'-8"	45.8	9.72	9.60	5.61
6½"	3½"	22	8'-9"	8'-3"	9'-4"	62.1	15.94	6.80	5.90
		20	10'-4"	10'-11"	11'-3"	62.5	16.93	8.11	7.36
		19	11'-4"	12'-2"	12'-7"	62.8	17.82	9.31	7.97
		18	11'-8"	13'-4"	13'-8"	63.1	18.62	10.41	7.97
		16	12'-4"	15'-0"	14'-6"	63.9	20.27	12.75	7.97
7½"	4½"	22	8'-2"	7'-2"	8'-2"	74.2	24.12	7.98	6.77
		20	9'-7"	10'-2"	10'-6"	74.6	25.57	9.52	8.23
		19	10'-9"	11'-5"	11'-9"	74.9	26.87	10.95	9.46
		18	11'-2"	12'-5"	12'-10"	75.2	28.04	12.26	9.70
		16	11'-10"	14'-0"	13'-11"	76.0	30.47	15.06	9.70

Note:

1. Maximum unshored spans do not consider web-crippling. Required bearing should be determined based on specific span conditions.

Superimposed Design Load, ϕW_n , / Deflection at L/360 (psf)

NWC (145 pcf), $f'_c = 3000$ psi

Total Slab Depth	Deck Gage	Span (ft-in.)							
		8'-0"	9'-0"	10'-0"	11'-0"	12'-0"	13'-0"	14'-0"	16'-0"
5"	22	592/643	456/451	360/329	288/247	233/190	191/149	157/120	108/80
	20	713/686	552/481	437/351	352/263	287/203	237/159	197/128	138/85
	19	825/724	641/508	509/370	411/278	337/214	279/168	233/135	166/90
	18	927/758	721/533	574/388	465/291	382/224	317/176	266/141	191/94
	16	1144/829	893/582	713/424	579/319	478/245	399/193	336/154	245/103
6½"	22	775/1360	597/955	469/696	375/523	303/403	247/317	203/253	138/170
	20	938/1445	725/1014	573/739	461/555	375/428	308/336	255/269	178/180
	19	1088/1521	843/1068	669/778	540/585	441/450	365/354	304/283	215/190
	18	1225/1589	952/1116	756/813	612/611	502/470	416/370	349/296	249/198
	16	1517/1729	1182/1214	943/885	766/665	631/512	527/403	443/322	321/216
7½"	22	907/2059	698/1446	548/1054	438/792	354/610	288/479	236/384	160/257
	20	1100/2182	850/1533	672/1117	540/839	439/646	361/508	299/407	208/272
	19	1278/2293	991/1611	785/1174	633/882	518/679	428/534	356/428	252/286
	18	1441/2393	1120/1681	890/1225	720/920	590/709	489/557	410/446	292/299
	16	1791/2600	1396/1826	1113/1331	904/1000	745/770	621/606	523/485	379/325

Notes:

1. For high loads long term concrete creep should be considered.
2. Use Composite Deck-Slab Strength Web Based Solutions for alternate slabs or ASD design.

3VLI-36/3VLJ-36/3PLVLI-36 COMPOSITE DECK-SLABS

LIGHT WEIGHT CONCRETE (110 pcf)

LRFD

			Maximum Unshored Spans			Composite Deck-Slab Properties			
Slab Depth		Deck Gage	Maximum Unshored Construction Clear Span			Concrete + Deck (psf)	Deflection $I_d = (I_{cr} + I_u)/2$ (in ⁴ /ft)	Moment ϕM_{no} (kip-ft/ft)	Shear ϕV_{no} (kip/ft)
Total	Topping		1	2	3				
5"	2"	22	11'-1"	11'-10"	12'-2"	33.8	5.75	4.95	4.02
		20	12'-7"	13'-8"	14'-1"	34.2	6.19	5.86	5.48
		19	13'-1"	15'-3"	15'-5"	34.5	6.59	6.70	5.61
		18	13'-6"	16'-7"	15'-10"	34.8	6.94	7.47	5.61
		16	14'-3"	17'-9"	16'-9"	35.6	7.66	9.09	5.61
5½"	2½"	22	10'-7"	11'-4"	11'-8"	38.4	7.51	5.45	4.30
		20	12'-2"	13'-1"	13'-6"	38.8	8.07	6.46	5.77
		19	12'-9"	14'-7"	14'-11"	39.1	8.57	7.39	6.36
		18	13'-2"	15'-11"	15'-5"	39.4	9.02	8.23	6.36
		16	13'-10"	17'-3"	16'-3"	40.2	9.93	10.02	6.36
6¼"	3¼"	22	9'-11"	10'-6"	11'-0"	45.2	10.78	6.26	4.75
		20	11'-9"	12'-4"	12'-9"	45.6	11.57	7.43	6.21
		19	12'-3"	13'-10"	14'-3"	45.9	12.27	8.51	7.44
		18	12'-8"	15'-1"	14'-10"	46.2	12.89	9.49	7.55
		16	13'-4"	16'-7"	15'-8"	47.0	14.16	11.56	7.55

Note:

- Maximum unshored spans do not consider web-crippling. Required bearing should be determined based on specific span conditions.

Superimposed Design Load, ϕW_n , / Deflection at L/360 (psf)

LWC (110 pcf), $f'_c = 3000$ psi

Total Slab Depth	Deck Gage	Span (ft-in.)							
		8'-0"	9'-0"	10'-0"	11'-0"	12'-0"	13'-0"	14'-0"	16'-0"
5"	22	577/491	448/344	355/251	286/188	234/145	193/114	161/91	114/61
	20	691/528	538/371	428/270	346/203	284/156	236/123	198/98	142/66
	19	796/562	620/395	494/287	401/216	331/166	275/131	232/104	168/70
	18	891/592	695/416	555/303	452/227	373/175	311/138	263/110	191/74
	16	1093/654	854/459	684/334	558/251	462/193	387/152	328/122	241/81
5½"	22	635/641	492/450	390/328	314/246	256/189	211/149	176/119	124/80
	20	761/689	591/483	470/352	380/265	312/204	259/160	217/128	155/86
	19	876/731	682/513	544/374	441/281	363/216	302/170	254/136	184/91
	18	981/769	765/540	611/394	497/296	410/228	342/179	288/143	210/96
	16	1204/847	941/595	753/433	614/325	508/251	426/197	360/158	264/105
6¼"	22	728/920	564/646	446/471	359/354	293/272	242/214	201/171	141/115
	20	874/987	679/693	540/505	436/379	358/292	297/230	248/184	177/123
	19	1008/1047	785/735	625/536	507/402	417/310	347/244	292/195	210/130
	18	1130/1100	881/772	703/563	571/423	471/325	393/256	331/205	240/137
	16	1388/1208	1085/848	868/618	707/464	585/358	490/281	415/225	304/151

Notes:

- For high loads long term concrete creep should be considered.
- Use Composite Deck-Slab Strength Web Based Solutions for alternate slabs or ASD design.

3VLI-36/3VLJ-36/3PLVLI-36 COMPOSITE DECK-SLABS

LRFD

3VLI-36/3VLJ-36/3PLVLI-36 Composite Deck-Slab Information

$f'_c = 3000$ psi

Total Slab Depth (in.)	Cover Depth (in.)	Theoretical Concrete Volume (yd ³ /100 ft ²)	Min. A _s for T&S (in. ²)	Recommended Reinforcing for Temperature and Shrinkage	
				WWR	(OR) Bekaert Dramix® Steel Fiber Alternate to WWR (lb/yd ³)
				4D 65/60BG	
Normal Weight Concrete (145 pcf)					
5	2	1.08	0.028	6x6-W1.4xW1.4	23
5½	2½	1.23	0.028	6x6-W1.4xW1.4	18
6	3	1.39	0.028	6x6-W1.4xW1.4	15
6½	3½	1.54	0.032	6x6-W2.1xW2.1	15
7	4	1.70	0.036	6x6-W2.1xW2.1	15
7½	4½	1.85	0.041	6x6-W2.1xW2.1	15
Light Weight Concrete (110 pcf)					
5	2	1.08	0.028	6x6-W1.4xW1.4	33
5½	2½	1.23	0.028	6x6-W1.4xW1.4	25
6	3	1.39	0.028	6x6-W1.4xW1.4	20
6¼	3¼	1.47	0.029	6x6-W2.1xW2.1	20
6½	3½	1.54	0.032	6x6-W2.1xW2.1	20
7¼	4¼	1.77	0.038	6x6-W2.1xW2.1	20

Notes:

1. FRC reinforcement is based on IAPMO UES ER-465.
2. Dramix® fibers may be used in UL or ULC fire rated assemblies in lieu of WWR. See UL file R19307 for additional information.

For information on Bekaert Dramix® fibers contact 770-514-2295 or infobuilding@bekaert.com.

NOTICE: Design defects that could cause injury or death may result from relying on the information in this document without independent verification by a qualified professional. The information in this document is provided "AS IS". Nucor Corporation and its affiliates expressly disclaim: (i) any and all representations, warranties and conditions and (ii) all liability arising out of or related to this document and the information in it.

NON-COMPOSITE DECK

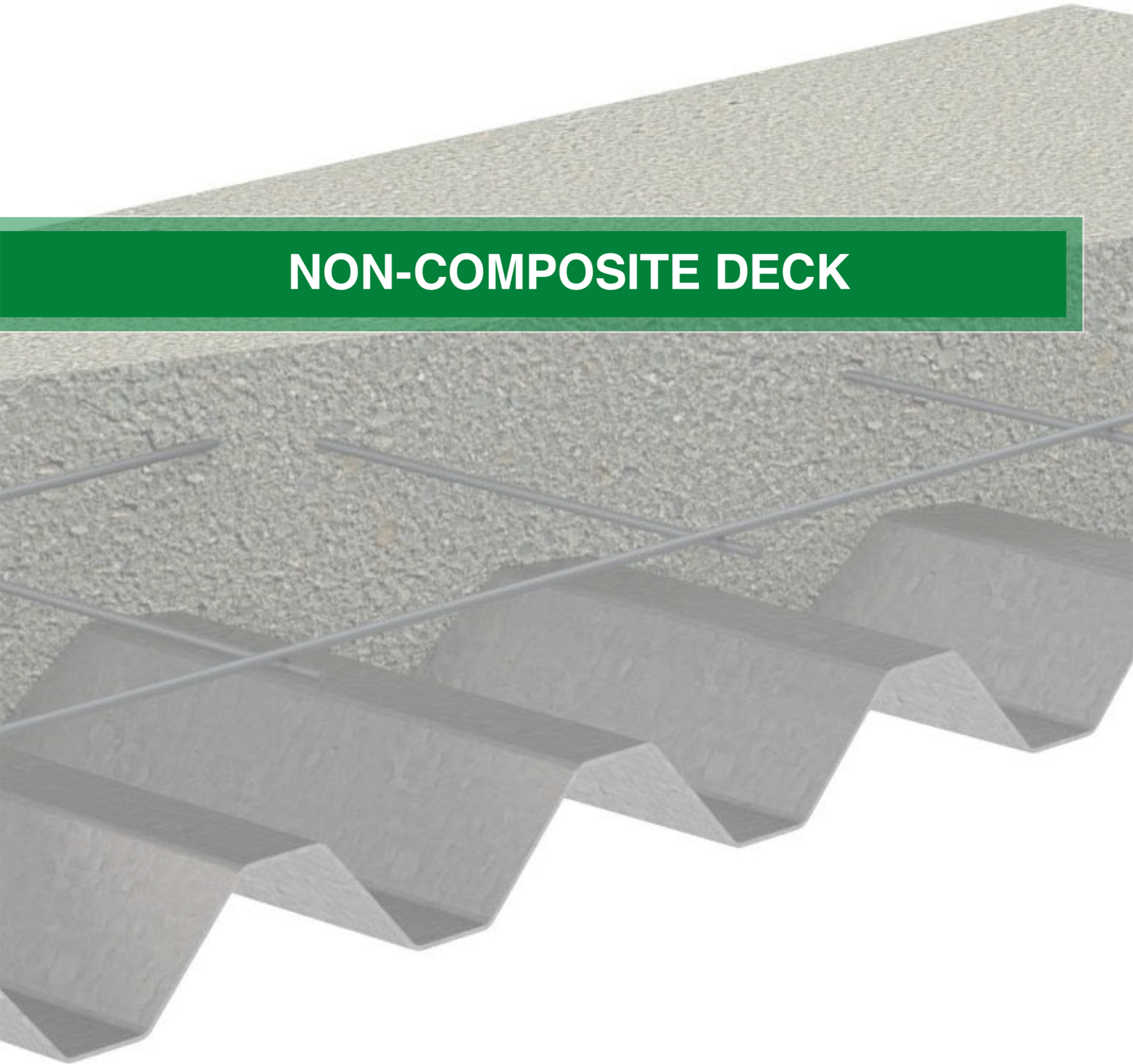

0.6C-30/0.6C-35 NON-COMPOSITE & ROOF DECKS GRADE 80 STEEL

LRFD

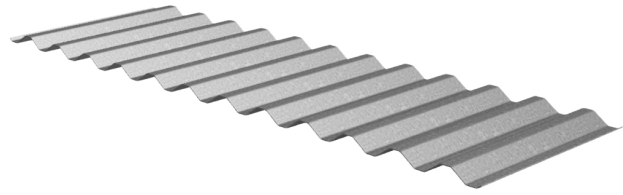
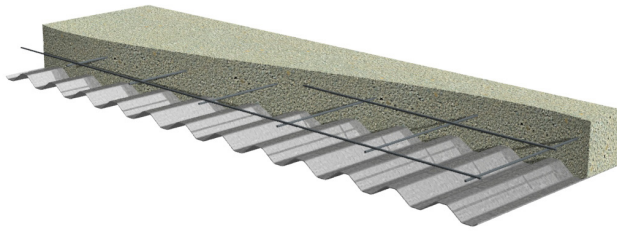

Nominal Dimensions

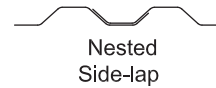
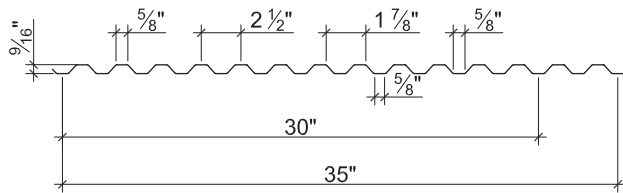

Section Properties

Deck Gage	Deck Weight w_{dd} (psf)	Base Metal Thickness t (in.)	Yield Strength F_y (ksi)	Effective Moment of Inertia at Service Load $I_d = (2I_e + I_g)/3$		Effective Section Modulus at $F_y = 60$ ksi		Design Moment		Vertical Web Shear ϕV_n (lb/ft)
				I_{d+} (in ⁴ /ft)	I_{d-} (in ⁴ /ft)	S_{e+} (in ³ /ft)	S_{e-} (in ³ /ft)	ϕM_{n+} (lb-ft/ft)	ϕM_{n-} (lb-ft/ft)	
28	0.7	0.0149	60	0.011	0.011	0.033	0.034	149	153	2016
26	0.9	0.0179	60	0.013	0.013	0.042	0.042	189	189	2415
24	1.2	0.0239	60	0.017	0.017	0.056	0.056	252	252	3202
22	1.4	0.0295	60	0.021	0.021	0.069	0.068	311	306	3927

Design Reactions at Supports Based on Web Crippling, ϕR_n (lb/ft)

Deck Gage	Bearing Length of Webs One-Flange Loading			
	End Bearing		Interior Bearing	
	1 1/2"	2"	1 1/2"	2"
28	751	807	844	899
26	1055	1130	1241	1317
24	1799	1913	2241	2364
22	2646	2800	3413	3583

Standard Features

- ASTM A653 SS GR80 with G60
- Standard lengths – 6'-0" to 42'-0"
- IAPMO UES ER-0652 and UL Listed
- Tables conform to ANSI/SDI NC-2017 and RD-2017

Optional Features

- Inquire regarding cost and lead times for:
 - Short cuts < 6'-0"
 - Sheet Lengths > 42'-0"
 - Alternative metallic and painted finishes
- Side-lap or bottom flange slot venting

0.6C-30/0.6C-35 NON-COMPOSITE & ROOF DECKS GRADE 80 STEEL

LRFD

Inward Uniform Design Loads, LRFD (psf)

Deck Gage	Spans	Criteria	Span (ft-in.)										
			1'-0"	1'-6"	2'-0"	2'-6"	3'-0"	3'-6"	4'-0"	4'-6"	5'-0"	5'-6"	6'-0"
28	Single	ϕW_n	1188	528	297	190	132	97	74	59	48	39	33
		L/240	721	214	90	46	27	17	11	8	6	4	3
	Double	ϕW_n	1144	527	301	194	135	99	76	60	49	40	34
		L/240	1737	515	217	111	64	41	27	19	14	10	8
	Triple	ϕW_n	1392	651	373	241	168	124	95	75	61	50	42
		L/240	1361	403	170	87	50	32	21	15	11	8	6
26	Single	ϕW_n	1512	672	378	242	168	123	95	75	60	50	42
		L/240	852	253	107	55	32	20	13	9	7	5	4
	Double	ϕW_n	1408	650	371	239	167	123	94	74	60	50	42
		L/240	2053	608	257	131	76	48	32	23	16	12	10
	Triple	ϕW_n	1711	802	460	297	207	153	117	93	75	62	52
		L/240	1609	477	201	103	60	38	25	18	13	10	7
24	Single	ϕW_n	2016	896	504	323	224	165	126	100	81	67	56
		L/240	1114	330	139	71	41	26	17	12	9	7	5
	Double	ϕW_n	1876	867	495	319	222	164	125	99	80	66	56
		L/240	2685	795	336	172	99	63	42	29	21	16	12
	Triple	ϕW_n	2279	1068	613	396	277	204	156	124	100	83	70
		L/240	2104	623	263	135	78	49	33	23	17	13	10
22	Single	ϕW_n	2484	1104	621	397	276	203	155	123	99	82	69
		L/240	1377	408	172	88	51	32	22	15	11	8	6
	Double	ϕW_n	2281	1053	601	387	270	199	152	120	98	81	68
		L/240	3316	983	415	212	123	77	52	36	27	20	15
	Triple	ϕW_n	2772	1298	745	481	336	248	190	150	122	101	85
		L/240	2599	770	325	166	96	61	41	29	21	16	12

Note:

1. Table does not account for web crippling. Required bearing should be determined based on specific span conditions.

NOTICE: Design defects that could cause injury or death may result from relying on the information in this document without independent verification by a qualified professional. The information in this document is provided "AS IS". Nucor Corporation and its affiliates expressly disclaim: (i) any and all representations, warranties and conditions and (ii) all liability arising out of or related to this document and the information in it.

0.6C-36 NON-COMPOSITE DECK & ROOF DECKS GRADE 80 STEEL

LRFD

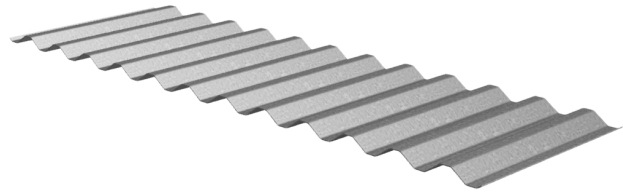
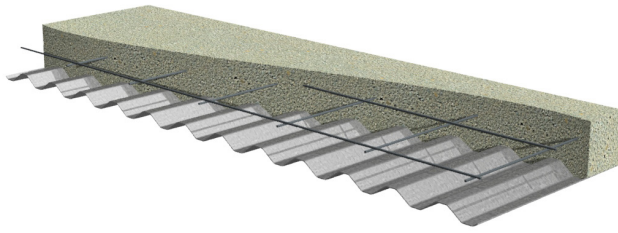

Nominal Dimensions

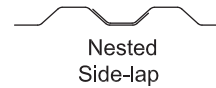
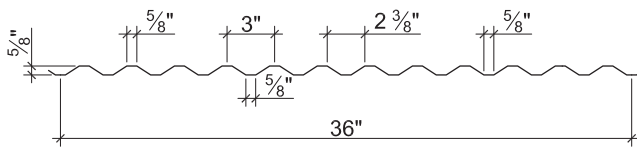

Section Properties

Deck Gage	Deck Weight w_{dd} (psf)	Base Metal Thickness t (in.)	Yield Strength F_y (ksi)	Effective Moment of Inertia at Service Load $I_d = (2I_e + I_g)/3$		Effective Section Modulus at $F_y = 60$ ksi		Design Moment		Vertical Web Shear ϕV_n (lb/ft)
				I_{d+} (in ⁴ /ft)	I_{d-} (in ⁴ /ft)	S_{e+} (in ³ /ft)	S_{e-} (in ³ /ft)	ϕM_{n+} (lb-ft/ft)	ϕM_{n-} (lb-ft/ft)	
28	0.7	0.0149	60	0.012	0.012	0.034	0.035	153	158	1810
26	0.9	0.0179	60	0.015	0.015	0.043	0.043	194	194	2613
24	1.1	0.0239	60	0.020	0.020	0.058	0.058	261	261	3634
22	1.4	0.0295	60	0.023	0.023	0.071	0.071	320	320	4474

Design Reactions at Supports Based on Web Crippling, ϕR_n (lb/ft)

Deck Gage	Bearing Length of Webs One-Flange Loading			
	End Bearing		Interior Bearing	
	1 1/2"	2"	1 1/2"	2"
28	533	592	698	766
26	750	831	1006	1100
24	1275	1406	1764	1921
22	1877	2063	2651	2875

Standard Features

- ASTM A653 SS GR80 with G60
- Standard lengths – 6'-0" to 42'-0"
- IAPMO UES ER-0652 and UL Listed
- Tables conform to ANSI/SDI NC-2017 and RD-2017

Optional Features

- Inquire regarding cost and lead times for:
 - Short cuts < 6'-0"
 - Sheet Lengths > 42'-0"
 - Alternative metallic and painted finishes
- Side-lap or bottom flange slot venting

0.6C-36 NON-COMPOSITE DECK & ROOF DECKS GRADE 80 STEEL

LRFD

Inward Uniform Design Loads, LRFD (psf)

Deck Gage	Spans	Criteria	Span (ft-in.)										
			1'-0"	1'-6"	2'-0"	2'-6"	3'-0"	3'-6"	4'-0"	4'-6"	5'-0"	5'-6"	6'-0"
28	Single	ϕW_n	1224	544	306	196	136	100	77	60	49	40	34
		L/240	787	233	98	50	29	18	12	9	6	5	4
	Double	ϕW_n	1155	538	308	199	139	102	78	62	50	42	35
		L/240	1895	561	237	121	70	44	30	21	15	11	9
	Triple	ϕW_n	1396	661	381	247	172	127	98	77	63	52	44
		L/240	1485	440	186	95	55	35	23	16	12	9	7
26	Single	ϕW_n	1548	688	387	248	172	126	97	76	62	51	43
		L/240	983	291	123	63	36	23	15	11	8	6	5
	Double	ϕW_n	1452	668	381	245	171	126	96	76	62	51	43
		L/240	2369	702	296	152	88	55	37	26	19	14	11
	Triple	ϕW_n	1768	825	472	305	213	157	120	95	77	64	54
		L/240	1857	550	232	119	69	43	29	20	15	11	9
24	Single	ϕW_n	2088	928	522	334	232	170	131	103	84	69	58
		L/240	1311	388	164	84	49	31	20	14	10	8	6
	Double	ϕW_n	1965	902	514	331	230	170	130	103	83	69	58
		L/240	3158	936	395	202	117	74	49	35	25	19	15
	Triple	ϕW_n	2397	1115	638	412	287	211	162	128	104	86	72
		L/240	2475	733	309	158	92	58	39	27	20	15	11
22	Single	ϕW_n	2556	1136	639	409	284	209	160	126	102	84	71
		L/240	1508	447	188	96	56	35	24	17	12	9	7
	Double	ϕW_n	2407	1105	629	405	282	208	159	126	102	84	71
		L/240	3632	1076	454	232	135	85	57	40	29	22	17
	Triple	ϕW_n	2937	1365	781	504	351	259	199	157	127	105	89
		L/240	2847	843	356	182	105	66	44	31	23	17	13

Note:

1. Table does not account for web crippling. Required bearing should be determined based on specific span conditions.

NOTICE: Design defects that could cause injury or death may result from relying on the information in this document without independent verification by a qualified professional. The information in this document is provided "AS IS". Nucor Corporation and its affiliates expressly disclaim: (i) any and all representations, warranties and conditions and (ii) all liability arising out of or related to this document and the information in it.

1.0C-32 NON-COMPOSITE & ROOF DECK GRADE 80 STEEL

LRFD

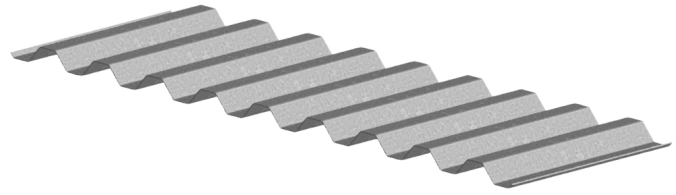
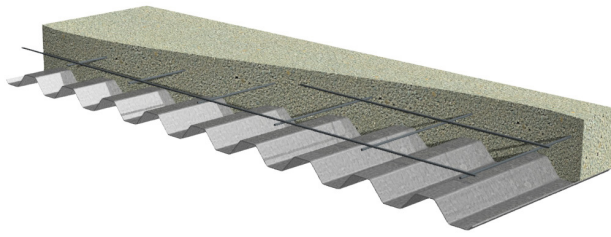

Nominal Dimensions

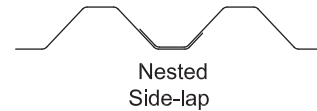
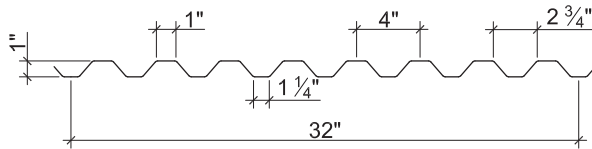

Section Properties

Deck Gage	Deck Weight w_{dd} (psf)	Base Metal Thickness t (in.)	Yield Strength F_y (ksi)	Effective Moment of Inertia at Service Load $I_d = (2I_e + I_g)/3$		Effective Section Modulus at $F_y = 60$ ksi		Design Moment		Vertical Web Shear ϕV_n (lb/ft)
				I_{d+} (in ⁴ /ft)	I_{d-} (in ⁴ /ft)	S_{e+} (in ³ /ft)	S_{e-} (in ³ /ft)	ϕM_{n+} (lb-ft/ft)	ϕM_{n-} (lb-ft/ft)	
26	0.9	0.0179	60	0.041	0.043	0.067	0.071	302	320	2542
24	1.2	0.0239	60	0.057	0.058	0.098	0.103	441	464	4441
22	1.5	0.0295	60	0.071	0.071	0.130	0.134	585	603	5468
20	1.9	0.0358	60	0.090	0.090	0.168	0.166	756	747	6617

Design Reactions at Supports Based on Web Crippling, ϕR_n (lb/ft)

Deck Gage	Bearing Length of Webs One-Flange Loading					
	End Bearing			Interior Bearing		
	1 1/2"	2"	3"	1 1/2"	2"	3"
26	733	812	944	1077	1178	1348
24	1247	1375	1590	1859	2024	2301
22	1833	2015	2320	2761	2995	3388
20	2611	2861	3280	3969	4291	4830

Standard Features

- ASTM A653 SS GR80 with G60
- Standard lengths – 6'-0" to 42'-0"
- IAPMO UES ER-0652 and UL Listed
- Tables conform to ANSI/SDI NC-2017 and RD-2017

Optional Features

- Inquire regarding cost and lead times for:
 - Short cuts < 6'-0"
 - Sheet Lengths > 42'-0"
 - Alternative metallic and painted finishes
- Side-lap or bottom flange slot venting

1.0C-32 NON-COMPOSITE & ROOF DECK GRADE 80 STEEL

LRFD

Inward Uniform Design Loads, LRFD (psf)

Deck Gage	Spans	Criteria	Span (ft-in.)										
			2'-0"	2'-6"	3'-0"	3'-6"	4'-0"	4'-6"	5'-0"	5'-6"	6'-0"	6'-6"	7'-0"
26	Single	ϕW_n	603	386	268	197	151	119	96	80	67	57	49
		L/240	336	172	100	63	42	29	22	16	12	10	8
	Double	ϕW_n	610	397	278	205	158	125	101	84	71	60	52
		L/240	849	435	251	158	106	75	54	41	31	25	20
	Triple	ϕW_n	747	489	344	255	196	156	126	105	88	75	65
		L/240	665	341	197	124	83	58	43	32	25	19	16
24	Single	ϕW_n	882	564	392	288	221	174	141	117	98	84	72
		L/240	467	239	138	87	58	41	30	22	17	14	11
	Double	ϕW_n	897	581	406	299	230	182	148	122	103	87	75
		L/240	1145	586	339	214	143	101	73	55	42	33	27
	Triple	ϕW_n	1106	719	504	372	286	227	184	152	128	109	94
		L/240	897	459	266	167	112	79	57	43	33	26	21
22	Single	ϕW_n	1170	749	520	382	293	231	187	155	130	111	96
		L/240	582	298	172	109	73	51	37	28	22	17	14
	Double	ϕW_n	1163	754	527	389	299	236	192	159	133	114	98
		L/240	1401	718	415	262	175	123	90	67	52	41	33
	Triple	ϕW_n	1431	933	654	484	372	295	239	198	166	142	123
		L/240	1098	562	325	205	137	96	70	53	41	32	26
20	Single	ϕW_n	1512	968	672	494	378	299	242	200	168	143	123
		L/240	738	378	219	138	92	65	47	35	27	21	17
	Double	ϕW_n	1438	933	653	482	370	293	238	197	165	141	122
		L/240	1777	910	526	331	222	156	114	85	66	52	41
	Triple	ϕW_n	1769	1154	810	599	460	365	296	245	206	176	152
		L/240	1392	713	413	260	174	122	89	67	52	41	32

Note:

1. Table does not account for web crippling. Required bearing should be determined based on specific span conditions.

NOTICE: Design defects that could cause injury or death may result from relying on the information in this document without independent verification by a qualified professional. The information in this document is provided "AS IS". Nucor Corporation and its affiliates expressly disclaim: (i) any and all representations, warranties and conditions and (ii) all liability arising out of or related to this document and the information in it.

1.0C-33 NON-COMPOSITE & ROOF DECK GRADE 80 STEEL

LRFD

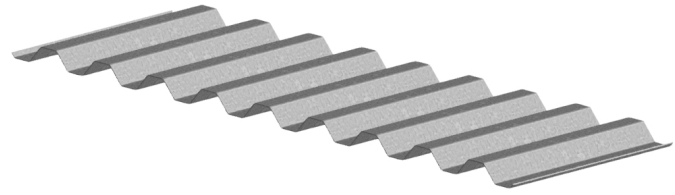
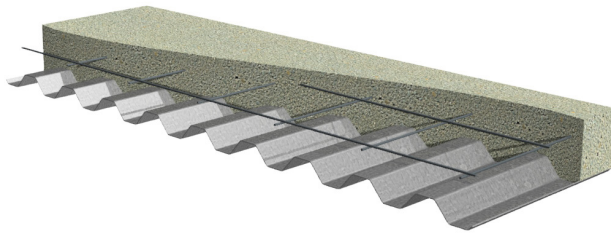

Nominal Dimensions

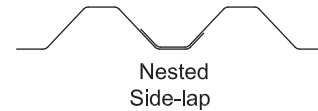
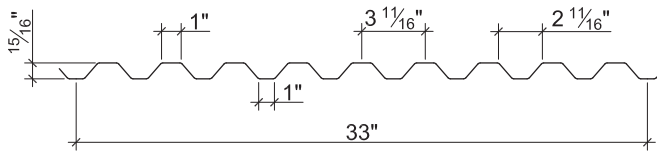

Section Properties

Deck Gage	Deck Weight w_{dd} (psf)	Base Metal Thickness t (in.)	Yield Strength F_y (ksi)	Effective Moment of Inertia at Service Load $I_d = (2I_e + I_g)/3$		Effective Section Modulus at $F_y = 60$ ksi		Design Moment		Vertical Web Shear ϕV_n (lb/ft)
				I_{d+} (in ⁴ /ft)	I_{d-} (in ⁴ /ft)	S_{e+} (in ³ /ft)	S_{e-} (in ³ /ft)	ϕM_{n+} (lb-ft/ft)	ϕM_{n-} (lb-ft/ft)	
26	0.9	0.0179	60	0.036	0.036	0.065	0.068	293	306	2442
24	1.2	0.0239	60	0.050	0.049	0.096	0.097	432	437	3239
22	1.5	0.0295	60	0.062	0.062	0.121	0.120	545	540	3972
20	1.8	0.0358	60	0.076	0.076	0.147	0.146	662	657	4785

Design Reactions at Supports Based on Web Crippling, ϕR_n (lb/ft)

Deck Gage	Bearing Length of Webs One-Flange Loading					
	End Bearing			Interior Bearing		
	1 1/2"	2"	3"	1 1/2"	2"	3"
26	737	816	876	757	828	881
24	1272	1403	1496	1435	1563	1653
22	1885	2072	2199	2244	2434	2562
20	2707	2965	3130	3356	3628	3801

Standard Features

- ASTM A653 SS GR80 with G60
- Standard lengths – 6'-0" to 42'-0"
- IAPMO UES ER-0652 and UL Listed
- Tables conform to ANSI/SDI NC-2017 and RD-2017

Optional Features

- Inquire regarding cost and lead times for:
 - Short cuts < 6'-0"
 - Sheet Lengths > 42'-0"
 - Alternative metallic and painted finishes
- Side-lap or bottom flange slot venting

1.0C-33 NON-COMPOSITE & ROOF DECK GRADE 80 STEEL

LRFD

Inward Uniform Design Loads, LRFD (psf)

Deck Gage	Spans	Criteria	Span (ft-in.)										
			2'-0"	2'-6"	3'-0"	3'-6"	4'-0"	4'-6"	5'-0"	5'-6"	6'-0"	6'-6"	7'-0"
26	Single	ϕW_n	585	374	260	191	146	116	94	77	65	55	48
		L/240	295	151	87	55	37	26	19	14	11	9	7
	Double	ϕW_n	584	380	266	197	151	120	97	80	68	58	50
		L/240	711	364	211	133	89	62	45	34	26	21	17
	Triple	ϕW_n	716	469	330	244	188	149	121	100	84	72	62
		L/240	557	285	165	104	70	49	36	27	21	16	13
24	Single	ϕW_n	864	553	384	282	216	171	138	114	96	82	71
		L/240	410	210	121	76	51	36	26	20	15	12	10
	Double	ϕW_n	827	539	379	280	215	171	138	115	96	82	71
		L/240	967	495	287	180	121	85	62	47	36	28	23
	Triple	ϕW_n	1012	664	468	347	267	212	172	143	120	103	88
		L/240	758	388	225	141	95	67	49	36	28	22	18
22	Single	ϕW_n	1089	697	484	356	272	215	174	144	121	103	89
		L/240	508	260	151	95	64	45	33	24	19	15	12
	Double	ϕW_n	1023	667	468	346	266	211	171	142	119	102	88
		L/240	1224	627	363	228	153	107	78	59	45	36	29
	Triple	ϕW_n	1250	821	579	429	331	262	213	177	149	127	109
		L/240	959	491	284	179	120	84	61	46	36	28	22
20	Single	ϕW_n	1323	847	588	432	331	261	212	175	147	125	108
		L/240	623	319	185	116	78	55	40	30	23	18	15
	Double	ϕW_n	1243	811	569	421	324	257	208	172	145	124	107
		L/240	1500	768	444	280	188	132	96	72	56	44	35
	Triple	ϕW_n	1519	998	704	522	402	319	259	215	181	154	133
		L/240	1176	602	348	219	147	103	75	57	44	34	27

Note:

1. Table does not account for web crippling. Required bearing should be determined based on specific span conditions.

NOTICE: Design defects that could cause injury or death may result from relying on the information in this document without independent verification by a qualified professional. The information in this document is provided "AS IS". Nucor Corporation and its affiliates expressly disclaim: (i) any and all representations, warranties and conditions and (ii) all liability arising out of or related to this document and the information in it.

1.0C-36 NON-COMPOSITE & ROOF DECK GRADE 80 STEEL

LRFD

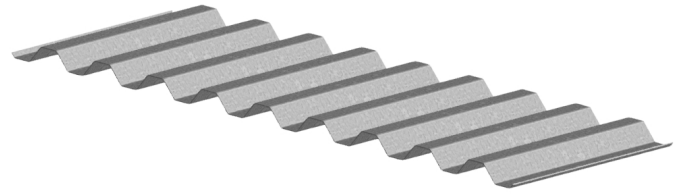
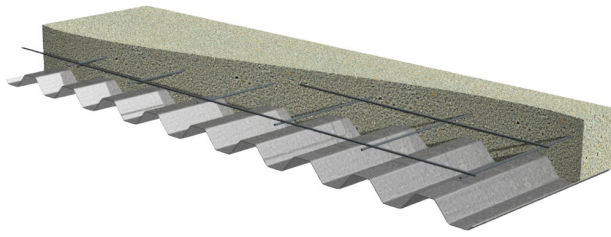

Nominal Dimensions

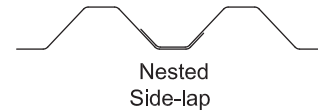
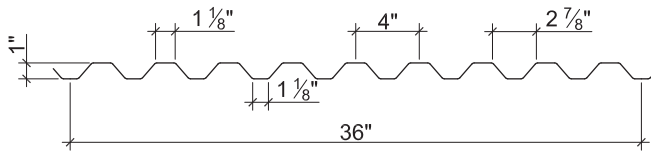

Section Properties

Deck Gage	Deck Weight w_{dd} (psf)	Base Metal Thickness t (in.)	Yield Strength F_y (ksi)	Effective Moment of Inertia at Service Load $I_d = (2I_e + I_g)/3$		Effective Section Modulus at $F_y = 60$ ksi		Design Moment		Vertical Web Shear ϕV_n (lb/ft)
				I_{d+} (in ⁴ /ft)	I_{d-} (in ⁴ /ft)	S_{e+} (in ³ /ft)	S_{e-} (in ³ /ft)	ϕM_{n+} (lb-ft/ft)	ϕM_{n-} (lb-ft/ft)	
26	0.9	0.0179	60	0.039	0.039	0.065	0.068	293	306	2518
24	1.2	0.0239	60	0.057	0.057	0.099	0.103	446	464	4186
22	1.5	0.0295	60	0.070	0.070	0.129	0.131	581	590	5152
20	1.8	0.0358	60	0.083	0.083	0.160	0.160	720	720	6232

Design Reactions at Supports Based on Web Crippling, ϕR_n (lb/ft)

Deck Gage	Bearing Length of Webs One-Flange Loading					
	End Bearing			Interior Bearing		
	1 1/2"	2"	3"	1 1/2"	2"	3"
26	710	786	915	979	1072	1226
24	1212	1336	1545	1717	1869	2125
22	1785	1962	2259	2573	2791	3157
20	2547	2790	3199	3725	4027	4533

Standard Features

- ASTM A653 SS GR80 with G60
- Standard lengths – 6'-0" to 42'-0"
- IAPMO UES ER-0652 and UL Listed
- Tables conform to ANSI/SDI NC-2017 and RD-2017

Optional Features

- Inquire regarding cost and lead times for:
 - Short cuts < 6'-0"
 - Sheet Lengths > 42'-0"
 - Alternative metallic and painted finishes
- Side-lap or bottom flange slot venting

1.0C-36 NON-COMPOSITE & ROOF DECK GRADE 80 STEEL

LRFD

Inward Uniform Design Loads, LRFD (psf)

Deck Gage	Spans	Criteria	Span (ft-in.)										
			2'-0"	2'-6"	3'-0"	3'-6"	4'-0"	4'-6"	5'-0"	5'-6"	6'-0"	6'-6"	7'-0"
26	Single	ϕW_n	585	374	260	191	146	116	94	77	65	55	48
		L/240	320	164	95	60	40	28	20	15	12	9	7
	Double	ϕW_n	586	381	267	197	151	120	97	80	68	58	50
		L/240	770	394	228	144	96	68	49	37	29	22	18
	Triple	ϕW_n	719	470	330	245	188	149	121	100	84	72	62
		L/240	603	309	179	113	75	53	39	29	22	18	14
24	Single	ϕW_n	891	570	396	291	223	176	143	118	99	84	73
		L/240	467	239	138	87	58	41	30	22	17	14	11
	Double	ϕW_n	893	579	405	299	230	182	147	122	103	87	75
		L/240	1125	576	333	210	141	99	72	54	42	33	26
	Triple	ϕW_n	1100	717	503	372	286	226	184	152	128	109	94
		L/240	882	452	261	165	110	77	56	42	33	26	21
22	Single	ϕW_n	1161	743	516	379	290	229	186	154	129	110	95
		L/240	574	294	170	107	72	50	37	28	21	17	13
	Double	ϕW_n	1134	736	515	380	292	231	187	155	130	111	96
		L/240	1382	707	409	258	173	121	88	66	51	40	32
	Triple	ϕW_n	1394	910	638	472	363	288	234	193	163	139	120
		L/240	1083	554	321	202	135	95	69	52	40	32	25
20	Single	ϕW_n	1440	922	640	470	360	284	230	190	160	136	118
		L/240	680	348	202	127	85	60	44	33	25	20	16
	Double	ϕW_n	1383	898	628	464	356	282	229	189	159	136	117
		L/240	1638	839	485	306	205	144	105	79	61	48	38
	Triple	ϕW_n	1701	1110	779	577	443	351	285	236	199	169	146
		L/240	1284	657	380	240	161	113	82	62	48	37	30

Note:

1. Table does not account for web crippling. Required bearing should be determined based on specific span conditions.

NOTICE: Design defects that could cause injury or death may result from relying on the information in this document without independent verification by a qualified professional. The information in this document is provided "AS IS". Nucor Corporation and its affiliates expressly disclaim: (i) any and all representations, warranties and conditions and (ii) all liability arising out of or related to this document and the information in it.

1.3C-32 NON-COMPOSITE DECK & ROOF DECK GRADE 80 STEEL

LRFD

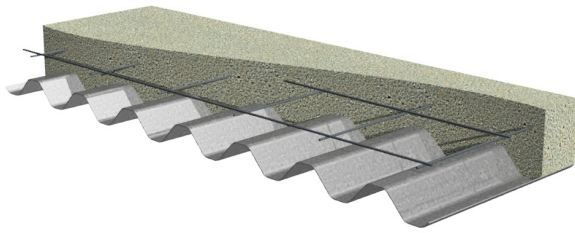

Nominal Dimensions

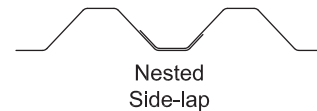
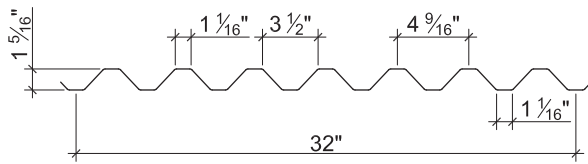

Section Properties

Deck Gage	Deck Weight w_{dd} (psf)	Base Metal Thickness t (in.)	Yield Strength F_y (ksi)	Effective Moment of Inertia at Service Load $I_d = (2I_e + I_g)/3$		Effective Section Modulus at $F_y = 60$ ksi		Design Moment		Vertical Web Shear ϕV_n (lb/ft)
				I_{d+} (in ⁴ /ft)	I_{d-} (in ⁴ /ft)	S_{e+} (in ³ /ft)	S_{e-} (in ³ /ft)	ϕM_{n+} (lb-ft/ft)	ϕM_{n-} (lb-ft/ft)	
26	0.9	0.0179	60	0.067	0.067	0.080	0.089	360	401	2161
24	1.3	0.0239	60	0.093	0.092	0.126	0.130	567	585	3857
22	1.6	0.0295	60	0.116	0.116	0.163	0.163	734	734	5292
20	1.9	0.0358	60	0.139	0.139	0.197	0.197	887	887	6401

Design Reactions at Supports Based on Web Crippling, ϕR_n (lb/ft)

Deck Gage	Bearing Length of Webs One-Flange Loading					
	End Bearing			Interior Bearing		
	1 1/2"	2"	3"	1 1/2"	2"	3"
26	539	597	695	585	640	732
24	939	1036	1197	1109	1207	1373
22	1400	1539	1772	1735	1882	2129
20	2017	2210	2533	2594	2804	3157

Standard Features

- ASTM A653 SS GR80 with G60
- Standard lengths – 6'-0" to 42'-0"
- IAPMO UES ER-652 and UL Listed
- Tables conform to ANSI/SDI NC-2017 and RD-2017

Optional Features

- Inquire regarding cost and lead times for:
 - Short cuts < 6'-0"
 - Sheet Lengths > 42'-0"
 - Alternative metallic and painted finishes
- Side-lap or bottom flange slot venting

1.3C-32 NON-COMPOSITE DECK & ROOF DECK GRADE 80 STEEL

LRFD

Inward Uniform Design Loads, LRFD (psf)

Deck Gage	Spans	Criteria	Span (ft-in.)										
			4'-0"	4'-6"	5'-0"	5'-6"	6'-0"	6'-6"	7'-0"	7'-6"	8'-0"	9'-0"	10'-0"
26	Single	ϕW_n	180	142	115	95	80	68	59	51	45	36	29
		L/240	69	48	35	26	20	16	13	10	9	6	4
	Double	ϕW_n	195	155	126	104	88	75	65	57	50	39	32
		L/240	165	116	85	64	49	39	31	25	21	15	11
	Triple	ϕW_n	241	192	156	130	109	93	81	70	62	49	40
		L/240	130	91	66	50	38	30	24	20	16	11	8
24	Single	ϕW_n	284	224	181	150	126	107	93	81	71	56	45
		L/240	95	67	49	37	28	22	18	14	12	8	6
	Double	ϕW_n	287	228	185	153	129	110	95	83	73	58	47
		L/240	227	159	116	87	67	53	42	34	28	20	15
	Triple	ϕW_n	357	283	230	191	161	137	118	103	91	72	58
		L/240	178	125	91	68	53	41	33	27	22	16	11
22	Single	ϕW_n	367	290	235	194	163	139	120	104	92	72	59
		L/240	119	83	61	46	35	28	22	18	15	10	8
	Double	ϕW_n	361	286	232	192	162	138	119	104	91	72	59
		L/240	286	201	147	110	85	67	53	43	36	25	18
	Triple	ϕW_n	449	356	289	240	202	172	149	130	114	90	73
		L/240	224	158	115	86	66	52	42	34	28	20	14
20	Single	ϕW_n	443	350	284	234	197	168	145	126	111	88	71
		L/240	142	100	73	55	42	33	27	22	18	12	9
	Double	ϕW_n	437	346	281	233	196	167	144	126	110	87	71
		L/240	343	241	176	132	102	80	64	52	43	30	22
	Triple	ϕW_n	542	430	350	290	244	208	180	157	138	109	88
		L/240	269	189	138	103	80	63	50	41	34	24	17

Note:

1. Table does not account for web crippling. Required bearing should be determined based on specific span conditions.

NOTICE: Design defects that could cause injury or death may result from relying on the information in this document without independent verification by a qualified professional. The information in this document is provided "AS IS". Nucor Corporation and its affiliates expressly disclaim: (i) any and all representations, warranties and conditions and (ii) all liability arising out of or related to this document and the information in it.

1.5C-36 NON-COMPOSITE DECK GRADE 50 STEEL

LRFD

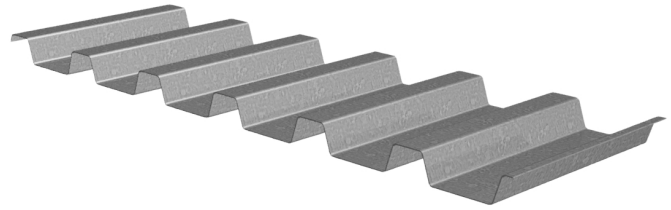
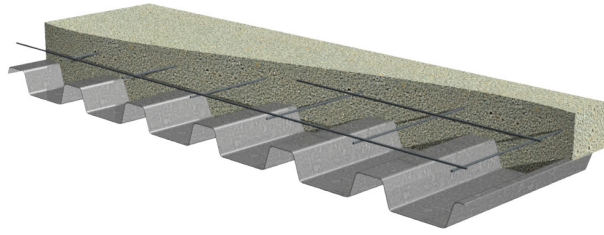

Nominal Dimensions

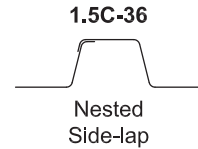
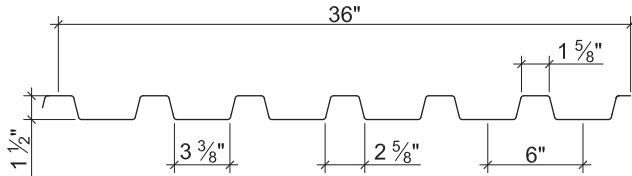

Section Properties

Deck Gage	Deck Weight w_{dd} (psf)	Base Metal Thickness t (in.)	Yield Strength F_y (ksi)	Effective Moment of Inertia at Service Load $I_d = (2I_e + I_g)/3$		Effective Section Modulus at $F_y = 50$ ksi		Design Moment		Vertical Web Shear ϕV_n (lb/ft)
				I_{d+} (in ⁴ /ft)	I_{d-} (in ⁴ /ft)	S_{e+} (in ³ /ft)	S_{e-} (in ³ /ft)	ϕM_{n+} (lb-ft/ft)	ϕM_{n-} (lb-ft/ft)	
24	1.3	0.0239	60	0.138	0.118	0.131	0.120	590	540	2357
22	1.6	0.0295	50	0.178	0.155	0.179	0.169	671	634	4035
20	2.0	0.0358	50	0.217	0.197	0.229	0.224	859	840	4874
18	2.6	0.0474	50	0.290	0.277	0.318	0.306	1193	1148	6398

Design Reactions at Supports Based on Web Crippling, ϕR_n (lb/ft)

Deck Gage	Bearing Length of Webs											
	One-Flange Loading						Two-Flange Loading					
	End Bearing				Interior Bearing		End Bearing				Interior Bearing	
	1 1/2"	2"	3"	4"	3"	4"	1 1/2"	2"	3"	4"	3"	4"
24	1005	1108	1281	1405	1781	1933	977	1057	1190	1285	2171	2371
22	1235	1357	1563	1706	2204	2383	1289	1389	1556	1672	2728	2966
20	1763	1932	2215	2408	3164	3406	1949	2093	2333	2497	3960	4286
18	2954	3221	3669	3959	5334	5699	3515	3754	4156	4417	6762	7265

Standard Features

- ASTM A653 SS GR50 Min. with G60
-SS GR80 ($F_y=60$) for 24 gage
- Standard lengths – 6'-0" to 42'-0"
- IAPMO UES ER-0652 and UL Listed
- Tables conform to ANSI/SDI NC-2017

Optional Features

- Inquire regarding cost and lead times for:
 - Short cuts < 6'-0"
 - Sheet Lengths > 42'-0"
 - Alternative metallic and painted finishes

1.5C-36 NON-COMPOSITE DECK GRADE 50 STEEL

LRFD

Inward Uniform Design Loads, LRFD (psf)

Deck Gage	Spans	Criteria	Span (ft-in.)										
			4'-0"	4'-6"	5'-0"	5'-6"	6'-0"	6'-6"	7'-0"	7'-6"	8'-0"	9'-0"	10'-0"
24	Single	ϕW_n	295	233	189	156	131	112	96	84	74	58	47
		L/240	141	99	72	54	42	33	26	21	18	12	9
	Double	ϕW_n	260	207	168	140	118	101	87	76	67	53	43
		L/240	291	204	149	112	86	68	54	44	36	26	19
	Triple	ϕW_n	319	255	208	173	146	125	108	94	83	66	53
		L/240	228	160	117	88	68	53	43	35	29	20	15
22	Single	ϕW_n	336	265	215	178	149	127	110	95	84	66	54
		L/240	182	128	93	70	54	42	34	28	23	16	12
	Double	ϕW_n	311	247	200	166	140	119	103	90	79	62	51
		L/240	382	269	196	147	113	89	71	58	48	34	24
	Triple	ϕW_n	385	306	249	206	174	148	128	112	98	78	63
		L/240	300	211	153	115	89	70	56	45	37	26	19
20	Single	ϕW_n	429	339	275	227	191	163	140	122	107	85	69
		L/240	222	156	114	86	66	52	41	34	28	20	14
	Double	ϕW_n	410	326	265	219	185	158	136	119	104	83	67
		L/240	486	341	249	187	144	113	91	74	61	43	31
	Triple	ϕW_n	508	404	329	273	230	196	170	148	130	103	84
		L/240	381	268	195	147	113	89	71	58	48	33	24
18	Single	ϕW_n	596	471	382	315	265	226	195	170	149	118	95
		L/240	297	209	152	114	88	69	55	45	37	26	19
	Double	ϕW_n	560	445	361	300	252	215	186	162	143	113	91
		L/240	683	480	350	263	203	159	128	104	85	60	44
	Triple	ϕW_n	693	551	449	372	314	268	231	202	178	141	114
		L/240	536	376	274	206	159	125	100	81	67	47	34

Note:

1. Table does not account for web crippling. Required bearing should be determined based on specific span conditions.

NOTICE: Design defects that could cause injury or death may result from relying on the information in this document without independent verification by a qualified professional. The information in this document is provided "AS IS". Nucor Corporation and its affiliates expressly disclaim: (i) any and all representations, warranties and conditions and (ii) all liability arising out of or related to this document and the information in it.

2C-36 NON-COMPOSITE DECK GRADE 50 STEEL

LRFD

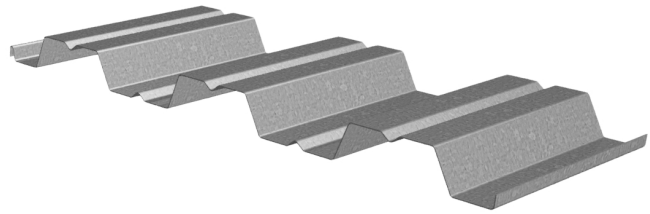
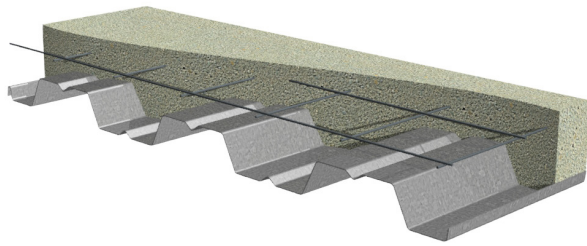

Nominal Dimensions

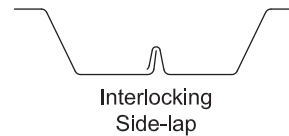
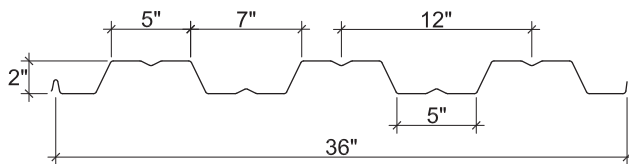

Section Properties

Deck Gage	Deck Weight w_{dd} (psf)	Base Metal Thickness t (in.)	Yield Strength F_y (ksi)	Effective Moment of Inertia at Service Load $I_d = (2I_e + I_g)/3$		Effective Section Modulus at $F_y = 50$ ksi		Design Moment		Vertical Web Shear ϕV_n (lb/ft)
				I_{d+} (in ⁴ /ft)	I_{d-} (in ⁴ /ft)	S_{e+} (in ³ /ft)	S_{e-} (in ³ /ft)	ϕM_{n+} (lb-ft/ft)	ϕM_{n-} (lb-ft/ft)	
22	1.6	0.0295	50	0.324	0.324	0.244	0.255	915	957	2495
20	1.9	0.0358	50	0.409	0.407	0.326	0.337	1222	1264	3677
18	2.5	0.0474	50	0.557	0.557	0.485	0.500	1819	1875	4925
16	3.2	0.0598	50	0.703	0.703	0.643	0.652	2411	2445	6185

Design Reactions at Supports Based on Web Crippling, ϕR_n (lb/ft)

Deck Gage	Bearing Length of Webs											
	One-Flange Loading						Two-Flange Loading					
	End Bearing				Interior Bearing		End Bearing				Interior Bearing	
	1½"	2"	3"	4"	4"	6"	1½"	2"	3"	4"	4"	6"
22	556	611	703	781	1141	1312	554	597	668	729	1374	1593
20	798	874	1002	1110	1634	1869	848	910	1015	1103	1997	2306
18	1345	1467	1671	1843	2741	3117	1550	1656	1833	1982	3410	3914
16	2071	2249	2548	2800	4202	4751	2530	2691	2962	3190	5287	6037

Standard Features

- ASTM A653 SS GR50 Min. with G60
- Standard lengths – 6'-0" to 42'-0"
- IAPMO UES ER-652 and UL Listed
- Tables conform to ANSI/SDI NC-2017

Optional Features

- Inquire regarding cost and lead times for:
 - Short cuts < 6'-0"
 - Sheet Lengths > 42'-0"
 - Alternative metallic and painted finishes
- Factory Hanger Tabs

2C-36 NON-COMPOSITE DECK GRADE 50 STEEL

LRFD

Inward Uniform Design Loads, LRFD (psf)

Deck Gage	Spans	Criteria	Span (ft-in.)										
			5'-0"	5'-6"	6'-0"	6'-6"	7'-0"	7'-6"	8'-0"	8'-6"	9'-0"	10'-0"	11'-0"
22	Single	ϕW_n	293	242	203	173	149	130	114	101	90	73	61
		L/240	170	128	98	77	62	50	41	35	29	21	16
	Double	ϕW_n	286	239	203	174	151	132	116	103	92	75	62
		L/240	409	308	237	186	149	121	100	83	70	51	38
	Triple	ϕW_n	348	292	248	213	185	163	144	128	114	93	77
		L/240	321	241	186	146	117	95	78	65	55	40	30
20	Single	ϕW_n	391	323	272	231	200	174	153	135	121	98	81
		L/240	214	161	124	98	78	64	52	44	37	27	20
	Double	ϕW_n	382	319	270	231	200	175	154	137	123	100	83
		L/240	514	386	298	234	187	152	126	105	88	64	48
	Triple	ϕW_n	467	391	332	285	247	217	191	170	152	124	103
		L/240	403	303	233	183	147	119	98	82	69	50	38
18	Single	ϕW_n	582	481	404	344	297	259	227	201	180	146	120
		L/240	292	219	169	133	106	87	71	59	50	37	27
	Double	ϕW_n	561	469	397	341	295	258	228	203	181	147	122
		L/240	704	529	407	320	256	208	172	143	121	88	66
	Triple	ϕW_n	682	572	487	419	364	319	282	251	224	183	152
		L/240	552	414	319	251	201	163	135	112	95	69	52
16	Single	ϕW_n	772	638	536	457	394	343	301	267	238	193	159
		L/240	369	277	213	168	134	109	90	75	63	46	35
	Double	ϕW_n	728	609	516	443	384	336	297	264	236	192	159
		L/240	888	667	514	404	324	263	217	181	152	111	83
	Triple	ϕW_n	884	742	632	544	473	414	366	326	292	238	198
		L/240	696	523	403	317	254	206	170	142	119	87	65

Note:

1. Table does not account for web crippling. Required bearing should be determined based on specific span conditions.

NOTICE: Design defects that could cause injury or death may result from relying on the information in this document without independent verification by a qualified professional. The information in this document is provided "AS IS". Nucor Corporation and its affiliates expressly disclaim: (i) any and all representations, warranties and conditions and (ii) all liability arising out of or related to this document and the information in it.

3C-36 NON-COMPOSITE DECK GRADE 50 STEEL

LRFD

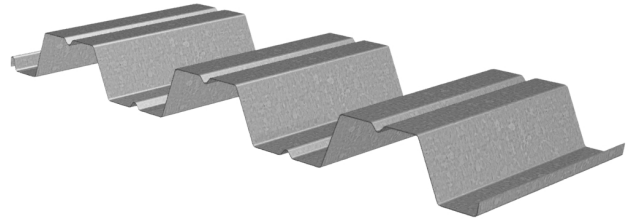
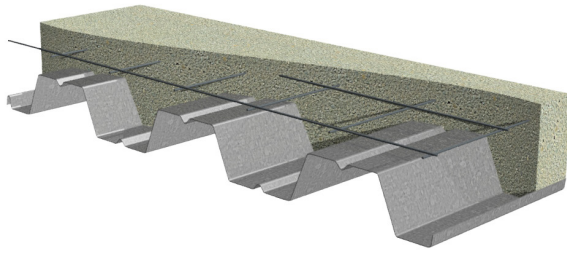

Nominal Dimensions

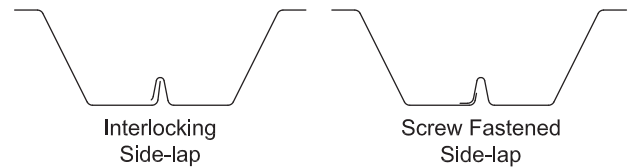
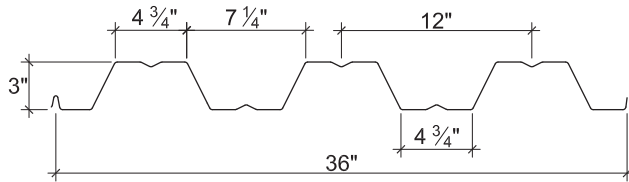

Section Properties

Deck Gage	Deck Weight w_{dd} (psf)	Base Metal Thickness t (in.)	Yield Strength F_y (ksi)	Effective Moment of Inertia at Service Load $I_d = (2I_e + I_g)/3$		Effective Section Modulus at $F_y = 50$ ksi		Design Moment		Vertical Web Shear ϕV_n (lb/ft)
				I_{d+} (in ⁴ /ft)	I_{d-} (in ⁴ /ft)	S_{e+} (in ³ /ft)	S_{e-} (in ³ /ft)	ϕM_n+ (lb-ft/ft)	ϕM_n- (lb-ft/ft)	
22	1.7	0.0295	50	0.732	0.737	0.387	0.410	1452	1537	2138
20	2.1	0.0358	50	0.919	0.921	0.512	0.539	1920	2021	3777
18	2.7	0.0474	50	1.253	1.253	0.761	0.794	2854	2977	6628
16	3.5	0.0598	50	1.580	1.580	1.013	1.013	3799	3799	9312

Design Reactions at Supports Based on Web Crippling, ϕR_n (lb/ft)

Deck Gage	Bearing Length of Webs											
	One-Flange Loading						Two-Flange Loading					
	End Bearing				Interior Bearing		End Bearing				Interior Bearing	
	1 1/2"	2"	3"	4"	4"	8"	1 1/2"	2"	3"	4"	4"	8"
22	540	593	683	759	1164	1354	510	549	615	671	1353	1588
20	780	855	980	1085	1668	2065	792	851	948	1031	1975	2481
18	1324	1444	1645	1814	2798	3504	1473	1573	1742	1883	3389	4314
16	2049	2226	2521	2771	4291	5324	2430	2585	2845	3065	5275	6656

Standard Features

- ASTM A653 SS GR50 Min. with G60
- Standard lengths – 6'-0" to 42'-0"
- IAPMO UES ER-652 and UL Listed
- Tables conform to ANSI/SDI NC-2017

Optional Features

- Inquire regarding cost and lead times for:
 - Short cuts < 6'-0"
 - Sheet Lengths > 42'-0"
 - Alternative metallic and painted finishes
- Factory Hanger Tabs

3C-36 NON-COMPOSITE DECK GRADE 50 STEEL

LRFD

Inward Uniform Design Loads, LRFD (psf)

Deck Gage	Spans	Criteria	Span (ft-in.)										
			6'-0"	7'-0"	7'-6"	8'-0"	8'-6"	9'-0"	9'-6"	10'-0"	11'-0"	12'-0"	13'-0"
22	Single	ϕW_n	323	237	206	181	161	143	129	116	96	81	69
		L/240	222	140	114	94	78	66	56	48	36	28	22
	Double	ϕW_n	293	223	197	175	157	141	127	116	97	82	70
		L/240	539	339	276	227	190	160	136	116	87	67	53
	Triple	ϕW_n	347	267	237	211	190	171	155	141	118	100	86
		L/240	422	266	216	178	149	125	106	91	69	53	42
20	Single	ϕW_n	427	313	273	240	213	190	170	154	127	107	91
		L/240	279	176	143	118	98	83	70	60	45	35	27
	Double	ϕW_n	410	308	271	240	213	191	172	156	130	110	94
		L/240	673	424	345	284	237	200	170	145	109	84	66
	Triple	ϕW_n	495	375	330	293	262	235	212	192	160	136	116
		L/240	528	332	270	223	186	156	133	114	86	66	52
18	Single	ϕW_n	634	466	406	357	316	282	253	228	189	159	135
		L/240	380	239	195	160	134	113	96	82	62	48	37
	Double	ϕW_n	620	463	406	358	319	285	257	232	193	163	139
		L/240	916	577	469	386	322	271	231	198	149	115	90
	Triple	ϕW_n	754	567	498	441	393	352	317	287	239	202	172
		L/240	718	452	368	303	253	213	181	155	117	90	71
16	Single	ϕW_n	844	620	540	475	421	375	337	304	251	211	180
		L/240	480	302	246	202	169	142	121	104	78	60	47
	Double	ϕW_n	799	595	521	460	409	366	329	298	247	208	178
		L/240	1155	727	591	487	406	342	291	250	187	144	114
	Triple	ϕW_n	977	732	642	568	505	453	408	369	306	258	221
		L/240	905	570	464	382	318	268	228	196	147	113	89

Note:

1. Table does not account for web crippling. Required bearing should be determined based on specific span conditions.

NOTICE: Design defects that could cause injury or death may result from relying on the information in this document without independent verification by a qualified professional. The information in this document is provided "AS IS". Nucor Corporation and its affiliates expressly disclaim: (i) any and all representations, warranties and conditions and (ii) all liability arising out of or related to this document and the information in it.



CELLULAR DECK

1.5BP/1.5VLP CELLULAR DECKS GRADE 50 STEEL

LRFD

BP CELLULAR ROOF DECK

- 1.5BP Deck used with TSWs or BPs
- 1.5PLBP Deck used with PunchLok® II System

VLP CELLULAR COMPOSITE DECK

- 1.5VLP Deck used with TSWs or BPs
- 1.5PLVLP Deck used with PunchLok® II System

Nominal Dimensions

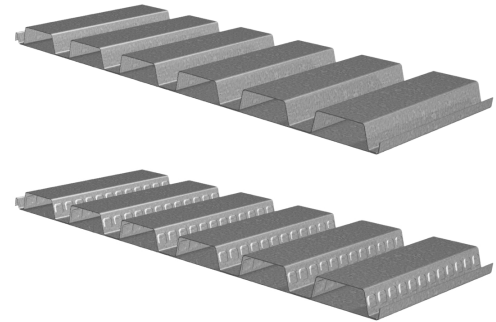
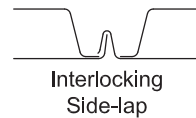
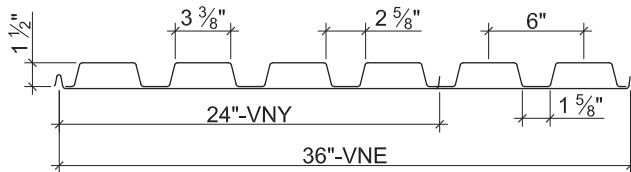

Plant	Cover Width	Pan Connection Method
VNY	24"	Flush Rivets (Underside)
VNE	36"	Resistance Welds

Section Properties

Deck Gage	Deck Weight w_{dd} (psf)	Base Metal Thickness t (in.)	Yield Strength F_y (ksi)	Effective Moment of Inertia at Service Load $I_d = (2I_e + I_g)/3$		Effective Section Modulus at $F_y = 50$ ksi		Design Moment		Vertical Web Shear ϕV_n (lb/ft)
				I_{d+} (in ⁴ /ft)	I_{d-} (in ⁴ /ft)	S_{e+} (in ³ /ft)	S_{e-} (in ³ /ft)	ϕM_{n+} (lb-ft/ft)	ϕM_{n-} (lb-ft/ft)	
20/20	3.6	0.0358/0.0358	50	0.393	0.293	0.272	0.240	1020	900	4874
20/18	4.1	0.0358/0.0474	50	0.428	0.315	0.280	0.259	1050	971	4874
18/20	4.1	0.0474/0.0358	50	0.504	0.369	0.405	0.312	1519	1170	6398
18/18	4.6	0.0474/0.0474	50	0.551	0.396	0.415	0.330	1556	1238	6398
18/16	5.1	0.0474/0.0598	50	0.594	0.423	0.425	0.350	1594	1313	6398
16/18	5.3	0.0598/0.0474	50	0.667	0.479	0.579	0.400	2171	1500	7996
16/16	5.8	0.0598/0.0598	50	0.721	0.510	0.591	0.421	2216	1579	7996

Design Reactions at Supports Based on Web Crippling, ϕR_n (lb/ft)

Deck Gage	Bearing Length of Webs											
	One-Flange Loading						Two-Flange Loading					
	End Bearing				Interior Bearing		End Bearing				Interior Bearing	
	1 1/2"	2"	3"	4"	3"	4"	1 1/2"	2"	3"	4"	3"	4"
20/XX	1763	1932	2215	2408	3164	3406	1949	2093	2333	2497	3960	4286
18/XX	2954	3221	3669	3959	5334	5699	3515	3754	4156	4417	6762	7265
16/XX	4525	4915	5568	5967	8206	8709	5681	6043	6651	7023	10487	11191

Standard Features

- ASTM A653 SS GR50 Min., with G60
- Standard lengths – 6'-0" to 42'-0"
- IAPMO UES ER-0652, UL, and FM Listed
- Tables conform to ANSI/SDI RD-2017 and C-2017

Optional Features

- Inquire regarding cost and lead times for:
 - Short Cuts < 6'-0"
 - Sheet Lengths > 42'-0"
 - Alternative metallic finishes
- Cellular Acoustical Versions

NOTICE: Design defects that could cause injury or death may result from relying on the information in this document without independent verification by a qualified professional. The information in this document is provided "AS IS". Nucor Corporation and its affiliates expressly disclaim: (i) any and all representations, warranties and conditions and (ii) all liability arising out of or related to this document and the information in it.

1.5BPA/1.5VLP A CELLULAR ACOUSTICAL DECKS

GRADE 50 STEEL

LRFD

BP CELLULAR ACOUSTICAL ROOF DECK

- 1.5BPA Deck used with TSWs or BPs
- 1.5PLBPA Deck used with PunchLok® II System

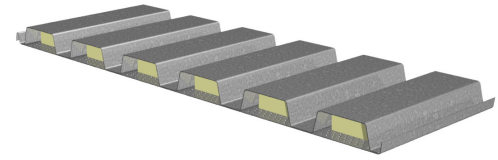

VLP CELLULAR ACOUSTICAL COMPOSITE DECK

- 1.5VPLA Deck used with TSWs or BPs
- 1.5PLVPA Deck used with PunchLok® II System

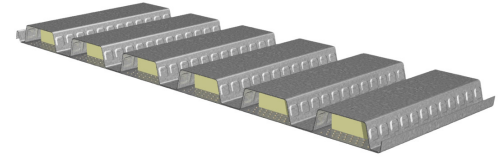

Nominal Dimensions

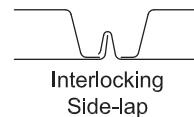
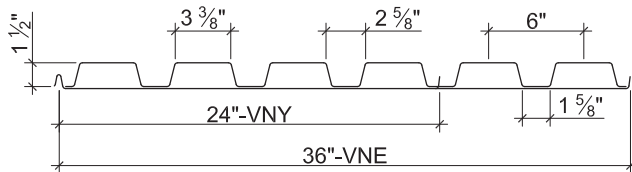

Plant	Cover Width	Pan Connection Method
VNY	24"	Flush Rivets (Underside)
VNE	36"	Resistance Welds

Section Properties

Deck Gage	Deck Weight w_{dd} (psf)	Base Metal Thickness t (in.)	Yield Strength F_y (ksi)	Effective Moment of Inertia at Service Load $I_d = (2I_e + I_g)/3$		Effective Section Modulus at $F_y = 50$ ksi		Design Moment		Vertical Web Shear ϕV_n (lb/ft)
				I_{d+} (in ⁴ /ft)	I_{d-} (in ⁴ /ft)	S_{e+} (in ³ /ft)	S_{e-} (in ³ /ft)	ϕM_{n+} (lb-ft/ft)	ϕM_{n-} (lb-ft/ft)	
20/20	3.3	0.0358/0.0358	50	0.380	0.293	0.270	0.240	1013	900	4874
20/18	3.8	0.0358/0.0474	50	0.414	0.315	0.277	0.259	1039	971	4874
18/20	4.0	0.0474/0.0358	50	0.485	0.369	0.400	0.312	1500	1170	6398
18/18	4.4	0.0474/0.0474	50	0.530	0.395	0.411	0.330	1541	1238	6398
18/16	4.9	0.0474/0.0598	50	0.572	0.407	0.420	0.311	1575	1166	6398
16/18	5.1	0.0598/0.0474	50	0.641	0.478	0.571	0.400	2141	1500	7996
16/16	5.6	0.0598/0.0598	50	0.692	0.492	0.583	0.380	2186	1425	7996

Design Reactions at Supports Based on Web Crippling, ϕR_n (lb/ft)

Deck Gage	Bearing Length of Webs											
	One-Flange Loading						Two-Flange Loading					
	End Bearing				Interior Bearing		End Bearing				Interior Bearing	
	1 1/2"	2"	3"	4"	3"	4"	1 1/2"	2"	3"	4"	3"	4"
20/XX	1763	1932	2215	2408	3164	3406	1949	2093	2333	2497	3960	4286
18/XX	2954	3221	3669	3959	5334	5699	3515	3754	4156	4417	6762	7265
16/XX	4525	4915	5568	5967	8206	8709	5681	6043	6651	7023	10487	11191

Standard Features

- ASTM A653 SS GR50 Min., with G60
- Standard lengths – 6'-0" to 42'-0"
- IAPMO UES ER-0652, UL, and FM Listed
- Tables conform to ANSI/SDI RD-2017 and C-2017

Optional Features

- Inquire regarding cost and lead times for:
 - Short Cuts < 6'-0"
 - Sheet Lengths > 42'-0"
 - Alternative metallic finishes

NOTICE: Design defects that could cause injury or death may result from relying on the information in this document without independent verification by a qualified professional. The information in this document is provided "AS IS". Nucor Corporation and its affiliates expressly disclaim: (i) any and all representations, warranties and conditions and (ii) all liability arising out of or related to this document and the information in it.

3NP-32/3PLNP-32 CELLULAR DECK GRADE 50 STEEL

LRFD

32" WIDE 3NP CELLULAR ROOF DECK

- 3NP-32 Deck used with TSWs or BPs
- 3PLNP-32 Deck used with PunchLok® II System

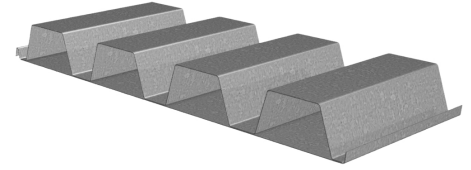

Nominal Dimensions

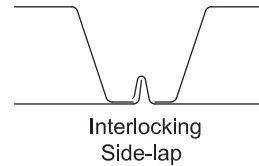
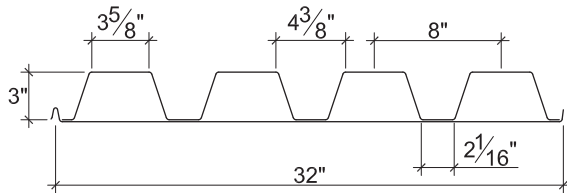

Plant	Cover Width	Pan Connection Method
VNE	32"	Resistance Welds

Section Properties

Deck Gage	Deck Weight w_{dd} (psf)	Base Metal Thickness t (in.)	Yield Strength F_y (ksi)	Effective Moment of Inertia at Service Load $I_d = (2I_e + I_g)/3$		Effective Section Modulus at $F_y = 50$ ksi		Design Moment		Vertical Web Shear ϕV_n (lb/ft)
				I_{d+} (in ⁴ /ft)	I_{d-} (in ⁴ /ft)	S_{e+} (in ³ /ft)	S_{e-} (in ³ /ft)	ϕM_{n+} (lb-ft/ft)	ϕM_{n-} (lb-ft/ft)	
20/20	3.7	0.0358/0.0358	50	1.519	1.153	0.496	0.492	1860	1845	5716
20/18	4.2	0.0358/0.0474	50	1.645	1.248	0.523	0.552	1961	2070	5716
18/20	4.4	0.0474/0.0358	50	1.931	1.460	0.786	0.674	2948	2528	10028
18/18	4.9	0.0474/0.0474	50	2.094	1.568	0.806	0.733	3023	2749	10028
18/16	5.5	0.0474/0.0598	50	2.243	1.699	0.806	0.822	3023	3083	10028
16/18	5.7	0.0598/0.0474	50	2.549	1.901	1.093	0.901	4099	3379	13777
16/16	6.2	0.0598/0.0598	50	2.732	2.046	1.116	0.998	4185	3743	13777

Design Reactions at Supports Based on Web Crippling, ϕR_n (lb/ft)

Deck Gage	Bearing Length of Webs											
	One-Flange Loading						Two-Flange Loading					
	End Bearing				Interior Bearing		End Bearing				Interior Bearing	
	1 1/2"	2"	3"	4"	4"	8"	1 1/2"	2"	3"	4"	4"	8"
20/XX	1184	1297	1487	1647	2524	3126	1206	1295	1444	1569	2996	3762
18/XX	2009	2191	2496	2752	4234	5304	2239	2392	2648	2864	5138	6540
16/XX	3108	3375	3823	4201	6493	8057	3693	3928	4323	4656	7994	10087

Standard Features

- ASTM A653 SS GR50 Min., with G60
- Standard lengths – 6'-0" to 42'-0"
- IAPMO UES ER-0652 and FM Listed
- Tables conform to ANSI/SDI RD-2017

Optional Features

- Inquire regarding cost and lead times for:
 - Short Cuts < 6'-0"
 - Sheet Lengths > 42'-0"
 - Alternative metallic finishes
- Cellular Acoustical Versions

NOTICE: Design defects that could cause injury or death may result from relying on the information in this document without independent verification by a qualified professional. The information in this document is provided "AS IS". Nucor Corporation and its affiliates expressly disclaim: (i) any and all representations, warranties and conditions and (ii) all liability arising out of or related to this document and the information in it.

3NPA-32/3PLNPA-32 CELLULAR ACOUSTICAL DECK GRADE 50 STEEL

LRFD

32" WIDE 3NPA CELLULAR ACOUSTICAL ROOF DECK

- 3NPA-32 Deck used with TSWs or BPs
- 3PLNPA-32 Deck used with PunchLok® II System

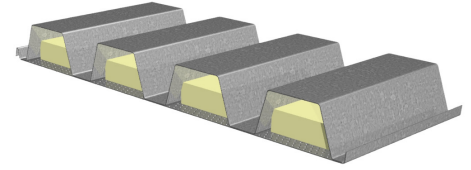

Nominal Dimensions

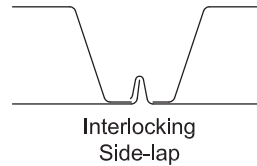
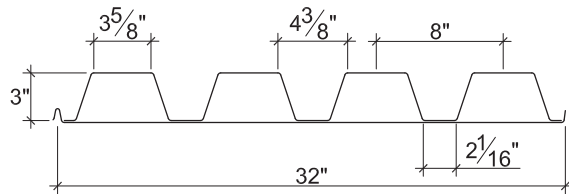

Plant	Cover Width	Pan Connection Method
VNE	32"	Resistance Welds

Section Properties

Deck Gage	Deck Weight w_{dd} (psf)	Base Metal Thickness t (in.)	Yield Strength F_y (ksi)	Effective Moment of Inertia at Service Load $I_d = (2I_e + I_g)/3$		Effective Section Modulus at $F_y = 50$ ksi		Design Moment		Vertical Web Shear ϕV_n (lb/ft)
				I_{d+} (in ⁴ /ft)	I_{d-} (in ⁴ /ft)	S_{e+} (in ³ /ft)	S_{e-} (in ³ /ft)	ϕM_{n+} (lb-ft/ft)	ϕM_{n-} (lb-ft/ft)	
20/20	3.6	0.0358/0.0358	50	1.458	1.152	0.491	0.492	1841	1845	5716
20/18	4.0	0.0358/0.0474	50	1.578	1.247	0.504	0.552	1890	2070	5716
18/20	4.3	0.0474/0.0358	50	1.851	1.459	0.775	0.674	2906	2528	10028
18/18	4.7	0.0474/0.0474	50	2.007	1.567	0.795	0.733	2981	2749	10028
18/16	5.2	0.0474/0.0598	50	2.151	1.636	0.797	0.745	2989	2794	10028
16/18	5.5	0.0598/0.0474	50	2.439	1.900	1.078	0.901	4043	3379	13777
16/16	6.0	0.0598/0.0598	50	2.613	1.980	1.101	0.908	4129	3405	13777

Design Reactions at Supports Based on Web Crippling, ϕR_n (lb/ft)

Deck Gage	Bearing Length of Webs											
	One-Flange Loading						Two-Flange Loading					
	End Bearing				Interior Bearing		End Bearing				Interior Bearing	
	1 1/2"	2"	3"	4"	4"	8"	1 1/2"	2"	3"	4"	4"	8"
20/XX	1184	1297	1487	1647	2524	3126	1206	1295	1444	1569	2996	3762
18/XX	2009	2191	2496	2752	4234	5304	2239	2392	2648	2864	5138	6540
16/XX	3108	3375	3823	4201	6493	8057	3693	3928	4323	4656	7994	10087

Standard Features

- ASTM A653 SS GR50 Min., with G60
- Standard lengths – 6'-0" to 42'-0"
- IAPMO UES ER-0652 and FM Listed
- Tables conform to ANSI/SDI RD-2017

Optional Features

- Inquire regarding cost and lead times for:
 - Short Cuts < 6'-0"
 - Sheet Lengths > 42'-0"
 - Alternative metallic finishes

NOTICE: Design defects that could cause injury or death may result from relying on the information in this document without independent verification by a qualified professional. The information in this document is provided "AS IS". Nucor Corporation and its affiliates expressly disclaim: (i) any and all representations, warranties and conditions and (ii) all liability arising out of or related to this document and the information in it.

3NP-24 CELLULAR DECK GRADE 40 STEEL

LRFD

24" WIDE 3NP CELLULAR ROOF DECK

- 3NP-24 Deck used with TSWs or BPs
- 3NPLP-24 Deck used with PunchLok® II System

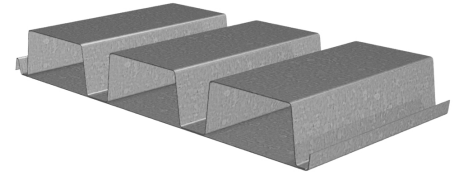

Nominal Dimensions

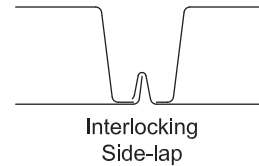
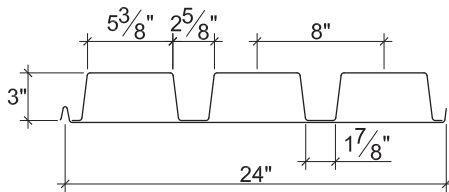

Plant	Cover Width	Pan Connection Method
VNY	24"	Flush Rivets (Underside)
VNE	24"	Resistance Welds

Section Properties

Deck Gage	Deck Weight w_{dd} (psf)	Base Metal Thickness t (in.)	Yield Strength F_y (ksi)	Effective Moment of Inertia at Service Load $I_d = (2I_e + I_g)/3$		Effective Section Modulus at $F_y = 40$ ksi		Design Moment		Vertical Web Shear ϕV_n (lb/ft)
				I_{d+} (in ⁴ /ft)	I_{d-} (in ⁴ /ft)	S_{e+} (in ³ /ft)	S_{e-} (in ³ /ft)	ϕM_{n+} (lb-ft/ft)	ϕM_{n-} (lb-ft/ft)	
20/20	3.9	0.0358/0.0358	40	1.754	1.420	0.528	0.543	1584	1629	5455
20/18	4.5	0.0358/0.0474	40	1.897	1.564	0.528	0.628	1584	1884	5455
18/20	4.7	0.0474/0.0358	40	2.246	1.774	0.821	0.707	2463	2121	8721
18/18	5.2	0.0474/0.0474	40	2.455	1.938	0.841	0.791	2523	2373	8721
18/16	5.8	0.0474/0.0598	40	2.641	2.136	0.858	0.921	2574	2763	8721
16/18	6.0	0.0598/0.0474	40	3.019	2.323	1.156	0.952	3468	2856	10951
16/16	6.6	0.0598/0.0598	40	3.259	2.543	1.180	1.082	3540	3246	10951

Design Reactions at Supports Based on Web Crippling, ϕR_n (lb/ft)

Deck Gage	Bearing Length of Webs											
	One-Flange Loading						Two-Flange Loading					
	End Bearing				Interior Bearing		End Bearing				Interior Bearing	
	1 1/2"	2"	3"	4"	4"	8"	1 1/2"	2"	3"	4"	4"	8"
20/XX	1021	1119	1282	1420	2158	2672	1050	1127	1257	1366	2577	3236
18/XX	1729	1886	2148	2369	3619	4532	1942	2074	2296	2483	4414	5618
16/XX	2670	2899	3284	3609	5543	6878	3191	3395	3736	4024	6856	8651

Standard Features

- ASTM A653 SS GR40 Min., with G60
- Standard lengths – 6'-0" to 42'-0"
- IAPMO UES ER-0652 and FM Listed
- Tables conform to ANSI/SDI RD-2017

Optional Features

- Inquire regarding cost and lead times for:
 - Short Cuts < 6'-0"
 - Sheet Lengths > 42'-0"
 - Alternative metallic finishes
- Cellular Acoustical Versions

NOTICE: Design defects that could cause injury or death may result from relying on the information in this document without independent verification by a qualified professional. The information in this document is provided "AS IS". Nucor Corporation and its affiliates expressly disclaim: (i) any and all representations, warranties and conditions and (ii) all liability arising out of or related to this document and the information in it.

3NPA-24 CELLULAR ACOUSTICAL DECK GRADE 40 STEEL

LRFD

24" WIDE 3NP CELLULAR ACOUSTICAL ROOF DECK

- 3NPA-24 Deck used with TSWs or BPs
- 3NPLPA-24 Deck used with PunchLok® II System

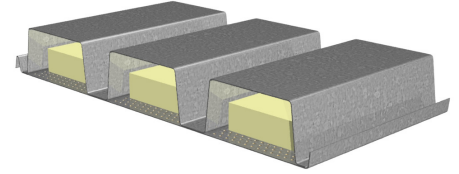

Nominal Dimensions

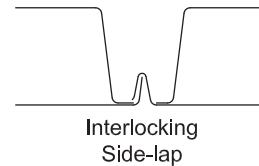
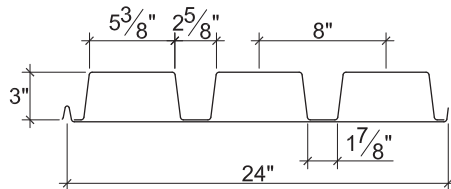

Plant	Cover Width	Pan Connection Method
VNY	24"	Flush Rivets (Underside)
VNE	24"	Resistance Welds

Section Properties

Deck Gage	Deck Weight w_{dd} (psf)	Base Metal Thickness t (in.)	Yield Strength F_y (ksi)	Effective Moment of Inertia at Service Load $I_d = (2I_e + I_g)/3$		Effective Section Modulus at $F_y = 40$ ksi		Design Moment		Vertical Web Shear ϕV_n (lb/ft)
				I_{d+} (in ⁴ /ft)	I_{d-} (in ⁴ /ft)	S_{e+} (in ³ /ft)	S_{e-} (in ³ /ft)	ϕM_{n+} (lb-ft/ft)	ϕM_{n-} (lb-ft/ft)	
20/20	3.8	0.0358/0.0358	40	1.684	1.419	0.522	0.543	1566	1629	5455
20/18	4.3	0.0358/0.0474	40	1.834	1.563	0.537	0.628	1611	1884	5455
18/20	4.6	0.0474/0.0358	40	2.151	1.773	0.809	0.707	2427	2121	8721
18/18	5.0	0.0474/0.0474	40	2.351	1.937	0.829	0.791	2487	2373	8721
18/16	5.6	0.0474/0.0598	40	2.532	2.035	0.847	0.797	2541	2391	8721
16/18	5.9	0.0598/0.0474	40	2.883	2.321	1.139	0.952	3417	2856	10951
16/16	6.4	0.0598/0.0598	40	3.111	2.434	1.163	0.955	3489	2865	10951

Design Reactions at Supports Based on Web Crippling, ϕR_n (lb/ft)

Deck Gage	Bearing Length of Webs											
	One-Flange Loading						Two-Flange Loading					
	End Bearing				Interior Bearing		End Bearing				Interior Bearing	
	1 1/2"	2"	3"	4"	4"	8"	1 1/2"	2"	3"	4"	4"	8"
20/XX	1021	1119	1282	1420	2158	2672	1050	1127	1257	1366	2577	3236
18/XX	1729	1886	2148	2369	3619	4532	1942	2074	2296	2483	4414	5618
16/XX	2670	2899	3284	3609	5543	6878	3191	3395	3736	4024	6856	8651

Standard Features

- ASTM A653 SS GR40 Min., with G60
- Standard lengths – 6'-0" to 42'-0"
- IAPMO UES ER-0652 and FM Listed
- Tables conform to ANSI/SDI RD-2017

Optional Features

- Inquire regarding cost and lead times for:
 - Short Cuts < 6'-0"
 - Sheet Lengths > 42'-0"
 - Alternative metallic finishes

NOTICE: Design defects that could cause injury or death may result from relying on the information in this document without independent verification by a qualified professional. The information in this document is provided "AS IS". Nucor Corporation and its affiliates expressly disclaim: (i) any and all representations, warranties and conditions and (ii) all liability arising out of or related to this document and the information in it.

2VLP CELLULAR COMPOSITE DECK GRADE 50 STEEL

LRFD

2VLP CELLULAR COMPOSITE DECK

- 2VLP Deck used with TSWs or BPs
- 2PLVLP Deck used with PunchLok® II System

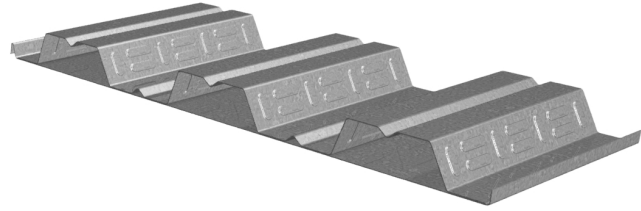

Nominal Dimensions

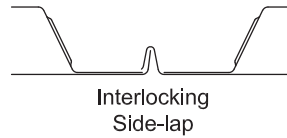
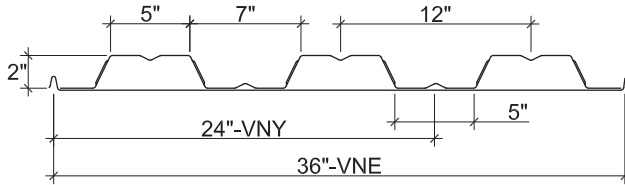

Plant	Cover Width	Pan Connection Method
VNY	24"	Flush Rivets (Underside)
VNE	36"	Resistance Welds

Section Properties

Deck Gage	Deck Weight w_{dd} (psf)	Base Metal Thickness t (in.)	Yield Strength F_y (ksi)	Effective Moment of Inertia at Service Load $I_d = (2I_e + I_g)/3$		Effective Section Modulus at $F_y = 50$ ksi		Design Moment		Vertical Web Shear ϕV_n (lb/ft)
				I_{d+} (in ⁴ /ft)	I_{d-} (in ⁴ /ft)	S_{e+} (in ³ /ft)	S_{e-} (in ³ /ft)	ϕM_{n+} (lb-ft/ft)	ϕM_{n-} (lb-ft/ft)	
20/20	3.3	0.0358/0.0358	50	0.670	0.491	0.369	0.303	1384	1136	3677
20/18	3.8	0.0358/0.0474	50	0.714	0.526	0.378	0.341	1418	1279	3677
18/20	3.9	0.0474/0.0358	50	0.854	0.635	0.547	0.432	2051	1620	4925
18/18	4.4	0.0474/0.0474	50	0.914	0.675	0.556	0.469	2085	1759	4925
18/16	5.0	0.0474/0.0598	50	0.967	0.716	0.565	0.511	2119	1916	4925
16/18	5.0	0.0598/0.0474	50	1.099	0.830	0.731	0.602	2741	2258	6185
16/16	5.6	0.0598/0.0598	50	1.165	0.877	0.742	0.643	2783	2411	6185

Design Reactions at Supports Based on Web Crippling, ϕR_n (lb/ft)

Deck Gage	Bearing Length of Webs											
	One-Flange Loading						Two-Flange Loading					
	End Bearing				Interior Bearing		End Bearing				Interior Bearing	
	1½"	2"	3"	4"	4"	6"	1½"	2"	3"	4"	4"	6"
20/XX	798	874	1002	1110	1634	1869	848	910	1015	1103	1997	2306
18/XX	1345	1467	1671	1843	2741	3117	1550	1656	1833	1982	3410	3914
16/XX	2071	2249	2548	2800	4202	4751	2530	2691	2962	3190	5287	6037

Standard Features

- ASTM A653 SS GR50 Min., with G60
- Standard lengths – 6'-0" to 42'-0"
- IAPMO UES ER-0652 and UL Listed
- Tables conform to ANSI/SDI C-2017

Optional Features

- Inquire regarding cost and lead times for:
 - Short Cuts < 6'-0"
 - Sheet Lengths > 42'-0"
 - Alternative metallic finishes
- Cellular Acoustical Versions

NOTICE: Design defects that could cause injury or death may result from relying on the information in this document without independent verification by a qualified professional. The information in this document is provided "AS IS". Nucor Corporation and its affiliates expressly disclaim: (i) any and all representations, warranties and conditions and (ii) all liability arising out of or related to this document and the information in it.

2VLPA CELLULAR ACOUSTICAL COMPOSITE DECK GRADE 50 STEEL

LRFD

2VLP CELLULAR ACOUSTICAL COMPOSITE DECK

- 2VLPA Deck used with TSWs or BPs
- 2PLVLPA Deck used with PunchLok® II System

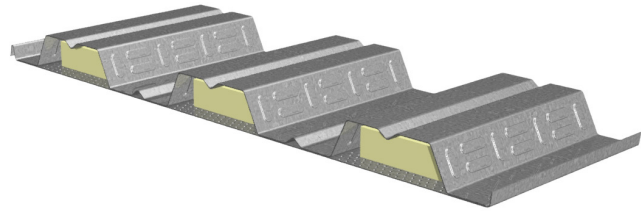

Nominal Dimensions

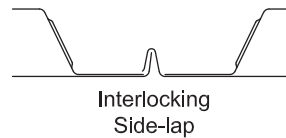
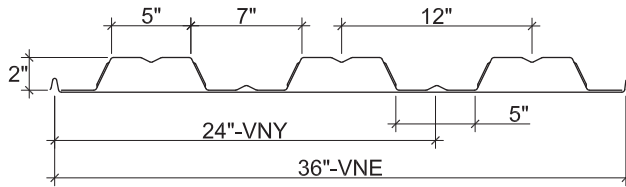

Plant	Cover Width	Pan Connection Method
VNY	24"	Flush Rivets (Underside)
VNE	36"	Resistance Welds

Section Properties

Deck Gage	Deck Weight w_{dd} (psf)	Base Metal Thickness t (in.)	Yield Strength F_y (ksi)	Effective Moment of Inertia at Service Load $I_d = (2I_e + I_g)/3$		Effective Section Modulus at $F_y = 50$ ksi		Design Moment		Vertical Web Shear ϕV_n (lb/ft)
				I_{d+} (in ⁴ /ft)	I_{d-} (in ⁴ /ft)	S_{e+} (in ³ /ft)	S_{e-} (in ³ /ft)	ϕM_{n+} (lb-ft/ft)	ϕM_{n-} (lb-ft/ft)	
20/20	3.2	0.0358/0.0358	50	0.655	0.491	0.367	0.303	1376	1136	3677
20/18	3.7	0.0358/0.0474	50	0.699	0.526	0.376	0.341	1410	1279	3677
18/20	3.8	0.0474/0.0358	50	0.834	0.634	0.543	0.432	2036	1620	4925
18/18	4.3	0.0474/0.0474	50	0.892	0.675	0.553	0.469	2074	1759	4925
18/16	4.8	0.0474/0.0598	50	0.945	0.716	0.562	0.511	2108	1916	4925
16/18	4.9	0.0598/0.0474	50	1.073	0.830	0.726	0.602	2723	2258	6185
16/16	5.4	0.0598/0.0598	50	1.137	0.877	0.737	0.643	2764	2411	6185

Design Reactions at Supports Based on Web Crippling, ϕR_n (lb/ft)

Deck Gage	Bearing Length of Webs											
	One-Flange Loading						Two-Flange Loading					
	End Bearing				Interior Bearing		End Bearing				Interior Bearing	
	1½"	2"	3"	4"	4"	6"	1½"	2"	3"	4"	4"	6"
20/XX	798	874	1002	1110	1634	1869	848	910	1015	1103	1997	2306
18/XX	1345	1467	1671	1843	2741	3117	1550	1656	1833	1982	3410	3914
16/XX	2071	2249	2548	2800	4202	4751	2530	2691	2962	3190	5287	6037

Standard Features

- ASTM A653 SS GR50 Min., with G60
- Standard lengths – 6'-0" to 42'-0"
- IAPMO UES ER-0652 and UL Listed
- Tables conform to ANSI/SDI C-2017

Optional Features

- Inquire regarding cost and lead times for:
 - Short Cuts < 6'-0"
 - Sheet Lengths > 42'-0"
 - Alternative metallic finishes

NOTICE: Design defects that could cause injury or death may result from relying on the information in this document without independent verification by a qualified professional. The information in this document is provided "AS IS". Nucor Corporation and its affiliates expressly disclaim: (i) any and all representations, warranties and conditions and (ii) all liability arising out of or related to this document and the information in it.

3VLP CELLULAR COMPOSITE DECK GRADE 50 STEEL

LRFD

3VLP CELLULAR COMPOSITE DECK

- 3VLP Deck used with TSWs or BPs
- 3PLVLP Deck used with PunchLok® II System

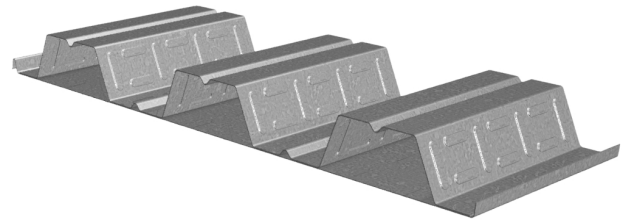

Nominal Dimensions

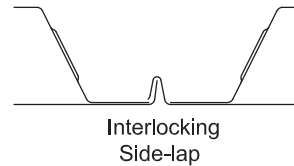
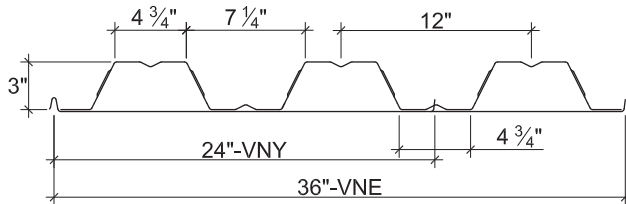

Plant	Cover Width	Pan Connection Method
VNY	24"	Flush Rivets (Underside)
VNE	36"	Resistance Welds

Section Properties

Deck Gage	Deck Weight w_{dd} (psf)	Base Metal Thickness t (in.)	Yield Strength F_y (ksi)	Effective Moment of Inertia at Service Load $I_d = (2I_e + I_g)/3$		Effective Section Modulus at $F_y = 50$ ksi		Design Moment		Vertical Web Shear ϕV_n (lb/ft)
				I_{d+} (in ⁴ /ft)	I_{d-} (in ⁴ /ft)	S_{e+} (in ³ /ft)	S_{e-} (in ³ /ft)	ϕM_{n+} (lb-ft/ft)	ϕM_{n-} (lb-ft/ft)	
20/20	3.5	0.0358/0.0358	50	1.490	1.082	0.545	0.465	2044	1744	3777
20/18	4.0	0.0358/0.0474	50	1.575	1.152	0.573	0.512	2149	1920	3777
18/20	4.2	0.0474/0.0358	50	1.881	1.398	0.860	0.670	3225	2513	6628
18/18	4.7	0.0474/0.0474	50	2.011	1.477	0.871	0.715	3266	2681	6628
18/16	5.2	0.0474/0.0598	50	2.127	1.579	0.869	0.798	3259	2993	6628
16/18	5.3	0.0598/0.0474	50	2.415	1.820	1.152	0.917	4320	3439	9312
16/16	5.9	0.0598/0.0598	50	2.557	1.932	1.169	1.002	4384	3758	9312

Design Reactions at Supports Based on Web Crippling, ϕR_n (lb/ft)

Deck Gage	Bearing Length of Webs											
	One-Flange Loading						Two-Flange Loading					
	End Bearing				Interior Bearing		End Bearing				Interior Bearing	
	1 1/2"	2"	3"	4"	4"	8"	1 1/2"	2"	3"	4"	4"	8"
20/XX	780	855	980	1085	1668	2065	792	851	948	1031	1975	2481
18/XX	1324	1444	1645	1814	2798	3504	1473	1573	1742	1883	3389	4314
16/XX	2049	2226	2521	2771	4291	5324	2430	2585	2845	3065	5275	6656

Standard Features

- ASTM A653 SS GR50 Min., with G60
- Standard lengths – 6'-0" to 42'-0"
- IAPMO UES ER-0652 and UL Listed
- Tables conform to ANSI/SDI C-2017

Optional Features

- Inquire regarding cost and lead times for:
 - Short Cuts < 6'-0"
 - Sheet Lengths > 42'-0"
 - Alternative metallic finishes
- Cellular Acoustical Versions

NOTICE: Design defects that could cause injury or death may result from relying on the information in this document without independent verification by a qualified professional. The information in this document is provided "AS IS". Nucor Corporation and its affiliates expressly disclaim: (i) any and all representations, warranties and conditions and (ii) all liability arising out of or related to this document and the information in it.

3VLPA CELLULAR ACOUSTICAL COMPOSITE DECK GRADE 50 STEEL

LRFD

3VLP CELLULAR ACOUSTICAL COMPOSITE DECK

- 3VLPA Deck used with TSWs or BPs
- 3PLVLP Deck used with PunchLok® II System

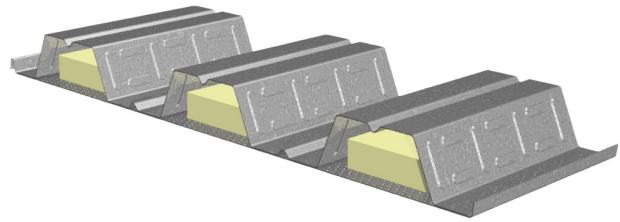

Nominal Dimensions

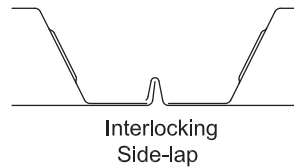
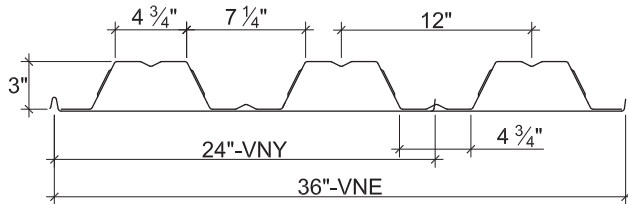

Plant	Cover Width	Pan Connection Method
VNY	24"	Flush Rivets (Underside)
VNE	36"	Resistance Welds

Section Properties

Deck Gage	Deck Weight w_{dd} (psf)	Base Metal Thickness t (in.)	Yield Strength F_y (ksi)	Effective Moment of Inertia at Service Load $I_d = (2I_e + I_g)/3$		Effective Section Modulus at $F_y = 50$ ksi		Design Moment		Vertical Web Shear ϕV_n (lb/ft)
				I_{d+} (in ⁴ /ft)	I_{d-} (in ⁴ /ft)	S_{e+} (in ³ /ft)	S_{e-} (in ³ /ft)	ϕM_{n+} (lb-ft/ft)	ϕM_{n-} (lb-ft/ft)	
20/20	3.4	0.0358/0.0358	50	1.457	1.082	0.543	0.465	2036	1744	3777
20/18	3.9	0.0358/0.0474	50	1.542	1.151	0.571	0.512	2141	1920	3777
18/20	4.1	0.0474/0.0358	50	1.837	1.398	0.853	0.670	3199	2513	6628
18/18	4.5	0.0474/0.0474	50	1.965	1.477	0.866	0.715	3248	2681	6628
18/16	5.0	0.0474/0.0598	50	2.078	1.578	0.864	0.798	3240	2993	6628
16/18	5.2	0.0598/0.0474	50	2.359	1.819	1.142	0.917	4283	3439	9312
16/16	5.7	0.0598/0.0598	50	2.496	1.931	1.159	1.002	4346	3758	9312

Design Reactions at Supports Based on Web Crippling, ϕR_n (lb/ft)

Deck Gage	Bearing Length of Webs											
	One-Flange Loading						Two-Flange Loading					
	End Bearing				Interior Bearing		End Bearing				Interior Bearing	
	1 1/2"	2"	3"	4"	4"	8"	1 1/2"	2"	3"	4"	4"	8"
20/XX	780	855	980	1085	1668	2065	792	851	948	1031	1975	2481
18/XX	1324	1444	1645	1814	2798	3504	1473	1573	1742	1883	3389	4314
16/XX	2049	2226	2521	2771	4291	5324	2430	2585	2845	3065	5275	6656

Standard Features

- ASTM A653 SS GR50 Min., with G60
- Standard lengths – 6'-0" to 42'-0"
- IAPMO UES ER-0652 and UL Listed
- Tables conform to ANSI/SDI C-2017

Optional Features

- Inquire regarding cost and lead times for:
 - Short Cuts < 6'-0"
 - Sheet Lengths > 42'-0"
 - Alternative metallic finishes

NOTICE: Design defects that could cause injury or death may result from relying on the information in this document without independent verification by a qualified professional. The information in this document is provided "AS IS". Nucor Corporation and its affiliates expressly disclaim: (i) any and all representations, warranties and conditions and (ii) all liability arising out of or related to this document and the information in it.